

Vertex Detectors - a historical overview

Chris Damerell (RAL, Open U and Oxford U)

CONTENTS

- **History from perspective of our RAL group – unavoidably biased ...**
- **Also, developments under study by our new collaboration (all pixel-based):**
 - **detectors for particle tracking systems with enhanced performance (notably much reduced material)**
 - **X-ray detectors for 4th generation light sources (FELs including UKFEL if it happens)**
 - **detectors for super-resolution optical microscopy**

1969 Expt S120. Hypercharge exchange processes at CERN PS. Tony G, Fred W, Blair Ratcliff

Clean test of the *bootstrap theory* of hadronic interactions

Ideas for a focusing spectrometer for SPS startup, to definitively test this theory

Need for few μm precision tracking ...

1970 Supported by Godfrey Stafford (amazingly, given his challenges when appointed Director of RHEL in 1969) - invited talk to the Lab's Scientific Policy Committee

Liquid-filled Wire Chambers

Because of diffusion effects (and other effects dependent on the mode of use) gas filled chambers (spark chambers or proportional wire chambers) are limited in resolution to a few tenths of a millimetre.

The Alvarez group has recently² observed electron multiplication in liquid argon. This opens the way for an improvement in precision of 2 orders of magnitude; resolution of $\sim 5\mu$ becomes a reasonable possibility.

The advantages are simple: that the high energy spectrometer ...

Visit to Alvarez group; initiated then shelved ideas for liquid xenon MWPC ..

1972 Bootstrap theory was disintegrating without our help. We joined CERN-Munich group to create the ACCMOR Collaboration, Experiment WA3; relatively conventional physics (meson spectroscopy with multi-particle spectrometer) but wonderful colleagues

Charm Pre-History and Discovery

1964 Bjorken and Glashow predicted the **charm quark** on general grounds. Key properties of D mesons included: decay nearly always to kaons, and with relatively high multiplicity. Physics case strengthened later by GIM mechanism to suppress strangeness-changing neutral currents. But as with the **Higgs boson**, experimental interest was at first non-existent – there was so much more ‘solid physics’ to do, such as discovering the patterns of meson and baryon resonances. The ‘naïve quark model’ was generally ridiculed

June 1974 Gaillard, Lee and Rosner: D lifetimes ‘might be measurable in emulsions’. Nobody reacted

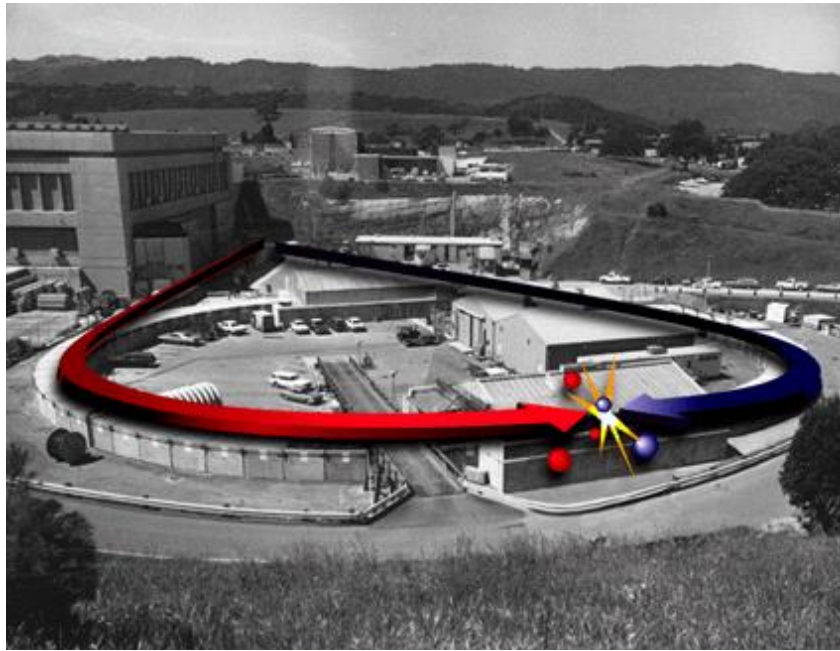

- SPEAR, an ‘unfunded’ unfashionable project, built on a parking lot, started running as an e^+e^- collider, which was a backwater of physics, in 1973
- Kjell Johnsen’s visit to SLAC
- Purpose of SPEAR? “Measure one number (R) then switch it off” Burt Richter was hoping R would rise with energy – plenty of events. Nobody thought about charm

- 1974 August, ICHEP Conference at IC London. Preliminary values of R in Mark I detector above 3 GeV were a bit high, and Burt urgently wanted to push to higher energy**
- John Ellis: ~30 predictions for development of R with energy – wildly different**
- John Iliopoulos talk to hadron spectroscopists – ‘Stop wasting your time, go and look for charm; it’s just round the corner’ (and his bet)**
- **After ICHEP, Richter decided to allow Marty Breidenbach and others just a week-end to explore lower energies. The ‘November Revolution’ on Sunday 10th November 1974 was followed by the Nobel Prize to Richter and Ting in 1976**



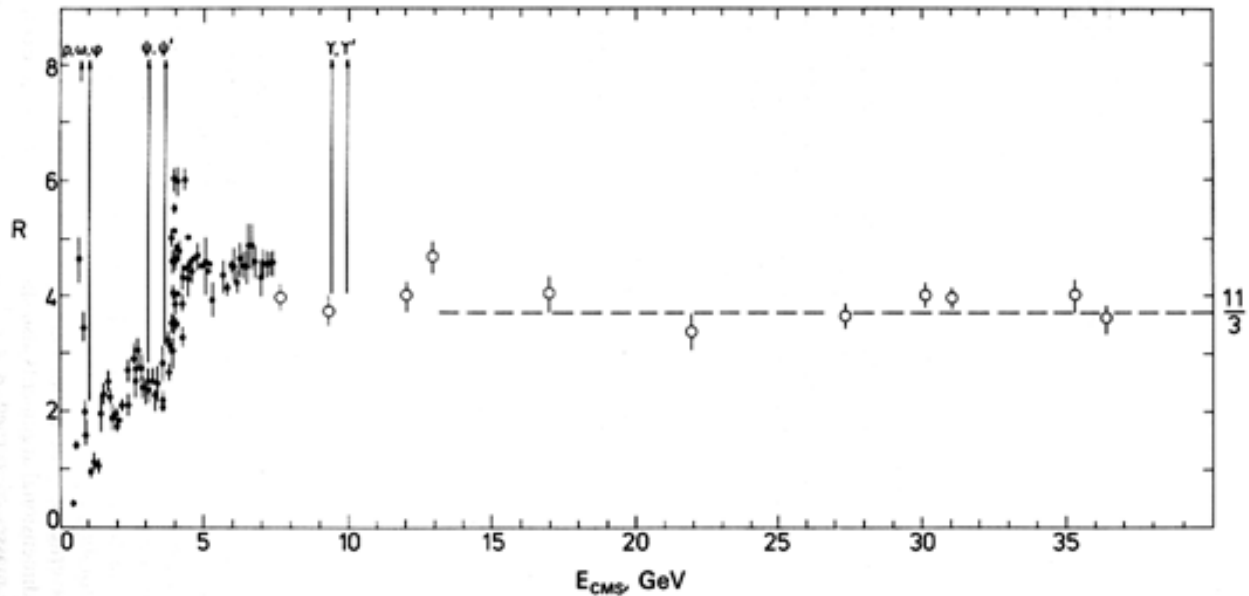

- There followed in Mark I the search for charm particles at $E_{CM} \sim 4\text{-}5$ GeV: it became desperate, and there was confusion for nearly a year
- Observations: R was too high; no increase in multiplicity; no excess of kaons; no D mesons; no smoking gun ...
- Initial frantic searches at Fermilab and CERN (SPS) also came up blank
- A new SLAC postdoc, **Haim Harari**, scrutinising the Mark I data, pulled all the evidence together brilliantly at the Lepton-Photon Conference in Stanford, August 1975
- He proposed two new things (charm quark and tau lepton) whose effects largely cancelled, so as to look like nothing. This interpretation was not immediately accepted ..
- Given the suggested tau lepton, he also predicted b and t quarks. The b quark was soon found (in 1977), but we had to wait 20 years for the top quark, both discovered at Fermilab

ACCMOR Response

Starting in 1974, we moved from the SPS West Area to a new high energy beam (200 GeV pions) in the North Hall, and onerously rebuilt our spectrometer as Experiment NA11; to measure **hadronic charm production**

We replaced spark chambers with drift chambers; a much longer and more powerful system of Cerenkov hodoscopes; increased from one to two spectrometer magnets; thin copper target. Overall length ~30 m

Our simulations demonstrated that this multi-particle spectrometer with excellent π/K identification would dramatically out-perform the collection of 2-arm spectrometers that had sprung up like weeds at the SPS and Fermilab, and had seen nothing. However, we saw that yet more power would be needed

Single electron trigger

20,000 wires of MWPCS from RAL plus a then-novel 'level 2' trigger (ESOP) from CERN/Munich to veto $e+e-$ pairs

Even with all this, our charm signals proved to be marginal. We were fortunately working in parallel to develop several approaches to the world's first **vertex detectors**:

- high pressure gaseous drift chamber (Blum)

- silicon microstrip detectors (Hyams/England – surface barrier diodes; then Lutz/Kemmer - ion implanted)

- silicon drift detector (Hyams then MPI)

- silicon active target (Klanner)

- pixel tracking detector using CCDs (RAL)

For the CCDs, we need to backtrack to 1970. While we were investigating liquid xenon and visiting Berkeley, we should instead have been paying attention to developments at Bell Labs, New Jersey



Boyle and Smith, circa 1974

This passed without notice by the particle physics community, but astronomers picked it up quickly

Craig McKay/Jonathan Wright in Cambridge: I was alerted by Francis Farley at a Cosenors House Meeting in 1979

'Plagued by **cosmic ray** background in their detector' ???

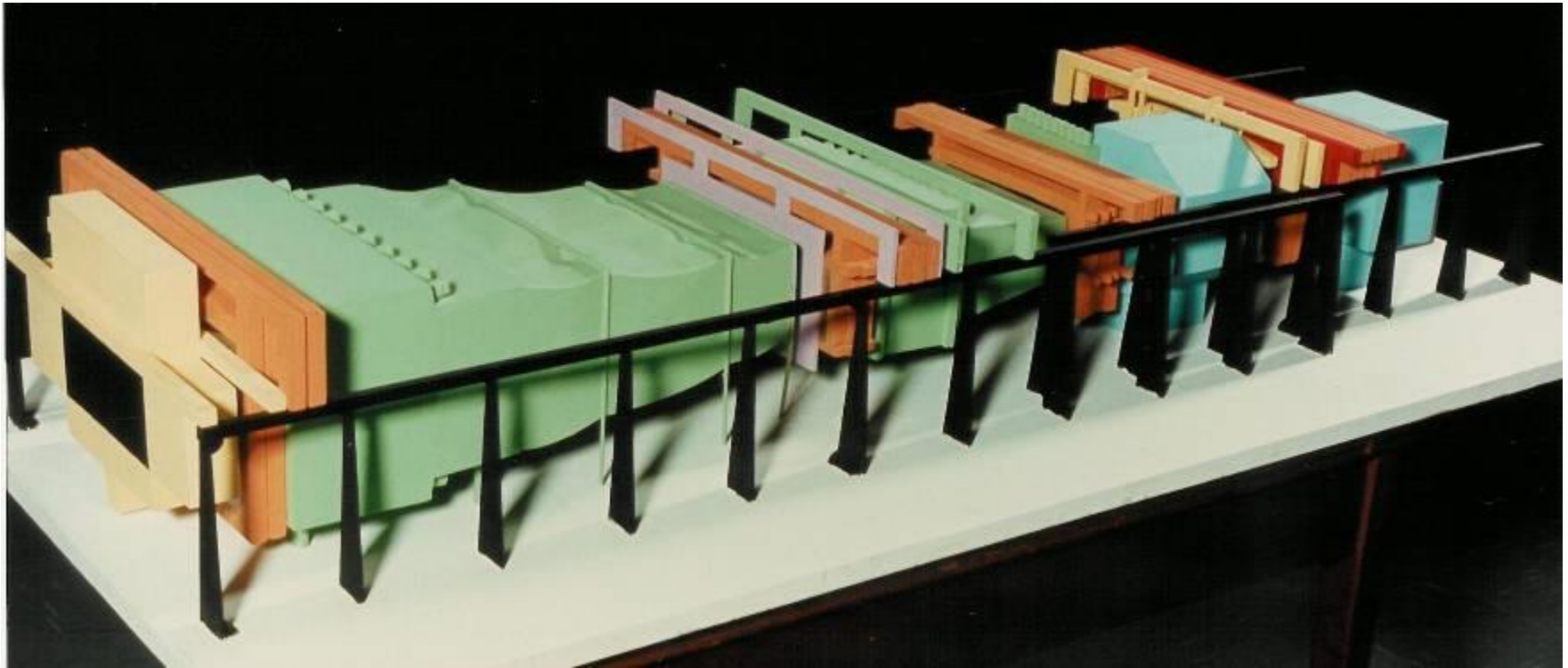

- **Model of NA11 spectrometer, L~30 m. We struggled for a couple of years to see charm production with our single electron trigger. Adding our first attempt at a vertex detector (6 planes of microstrip detectors) was a major step forward, but not sufficient**
- **After 5 years of simulations and intensive R&D with CCDs, in the lab at RAL and in the t6 test beam in the East Hall of the CERN PS, the Rutherford group was ready in 1984 to have a go. But we were considered to be ‘wasting your time’**
- **Several crates of champagne were eventually ‘won’ as a result**

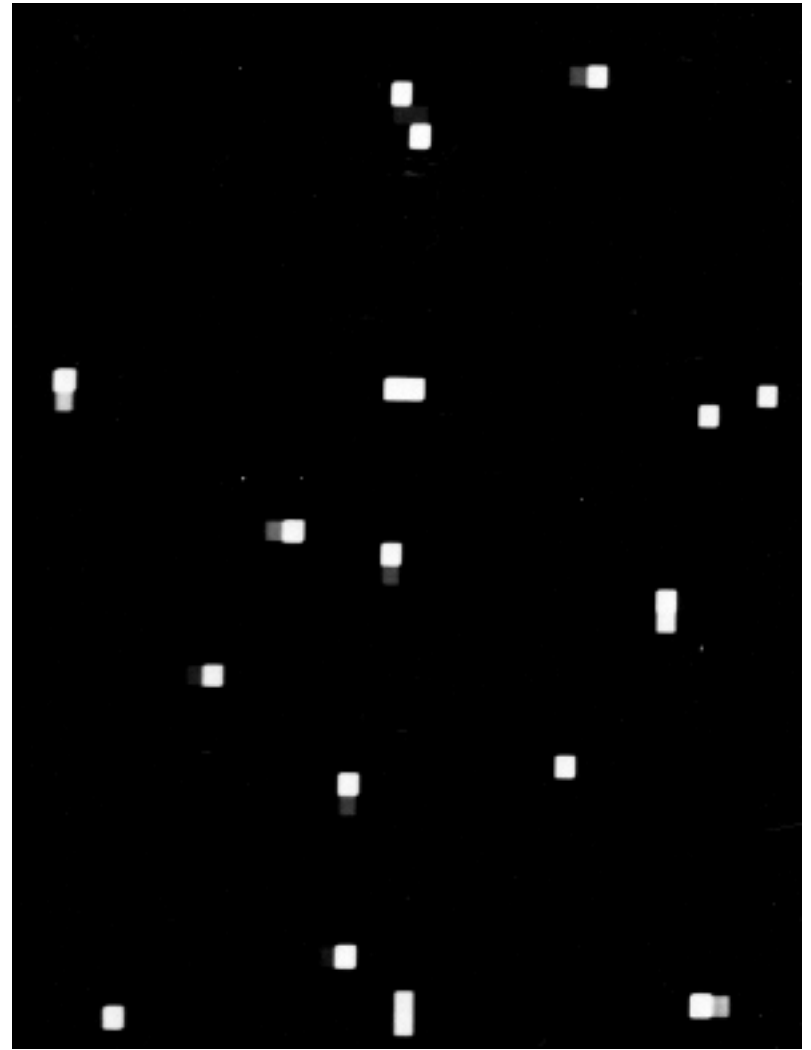

- Telescope in t6: 4 detector planes, 20 μm pixels
- 3.5 μm precision measured in X and Y
- This plot of 20 hits in 1 mm^2 made our group 'famous' – no other electronic detector had ever come close



NA32 Experiment
North Hall CERN 1984
Two CCDs, active area only 0.25 Mpixels each, 1 and 2 cm beyond the thin copper target.
This space was vacant

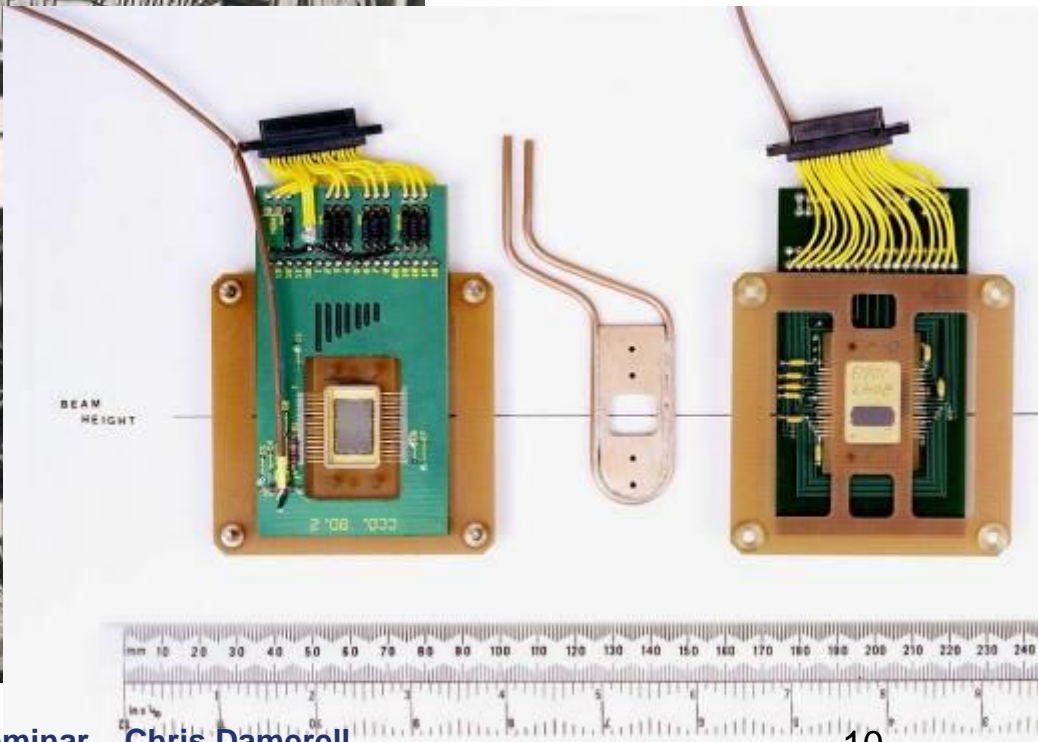
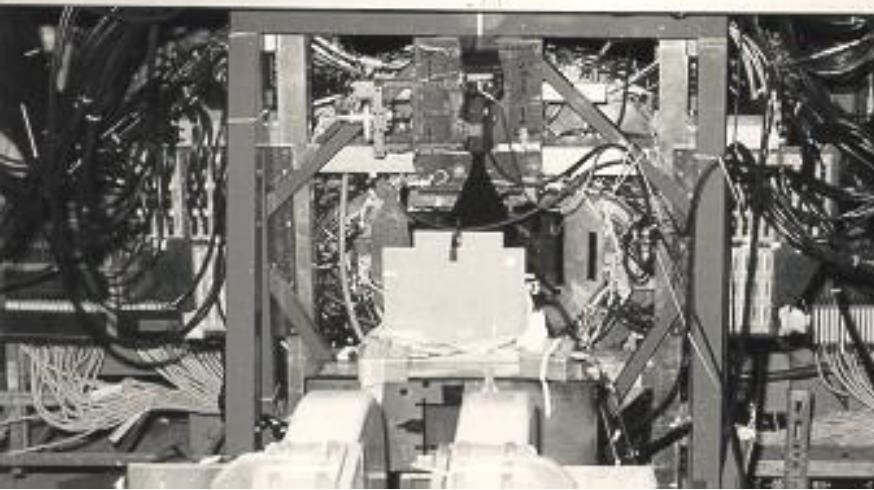

A pixel detector measures a unique space point in every layer, totally free of ghost hits

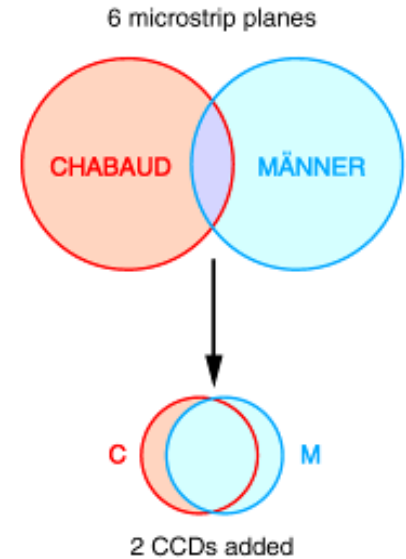
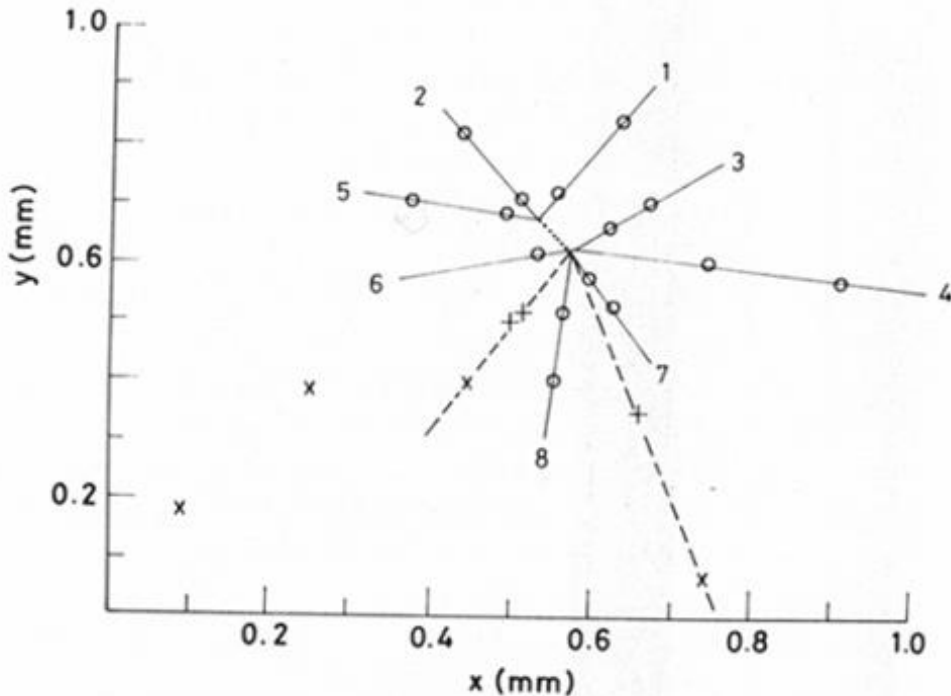

200 GeV 'jets', Clean pattern recognition with only two pixel planes

Fred Wickens on shift in 1984, 'Do you think this looks like a charm decay?'

[After momentum analysis and particle ID, it proved to be our first D^+]

While we had our hands full building this modest detector, and analysing the rich charm physics that poured out, we also had our eyes on the bigger goals associated with the next generation of e⁺e⁻ colliders, LEP and SLD

Our field had been blessed in 1977 with the discovery of the b quark, and the **really-surprising** even-longer lifetimes of B hadrons. Initial theoretical predictions had been unanimous: immeasurably short lifetimes $\sim 10^{-14}$ s, but experiment showed them to be 100 times greater, ie 10 times longer than charm particles.

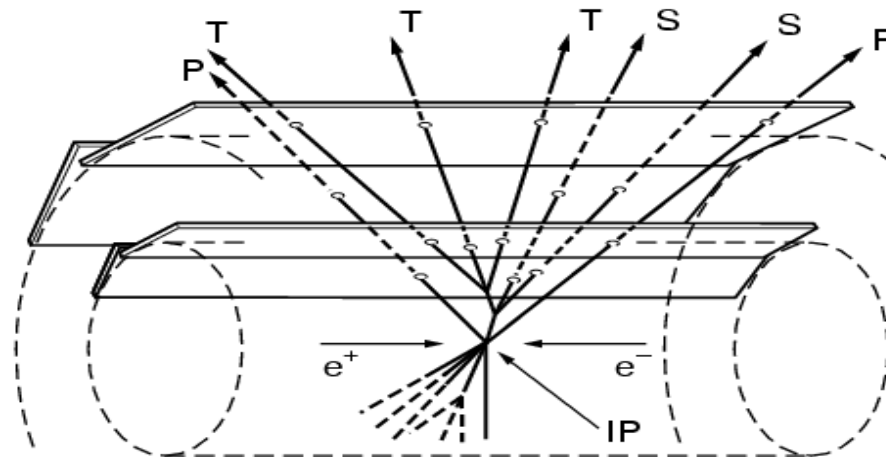

- **By 1984, it was widely accepted that vertex detectors were urgently needed in collider experiments, despite the much greater technical challenges:**

‘Some presently marginal signals (such as the top quark in UA1) could be transformed into definitive experimental results with the aid of vertex detectors ...’

Ch D, Proc SLAC Summer Institute 1984, p 45.

- **Discouraged by the prospects at LEP (Villars workshop June 1981), but captivated by discussions with Breidenbach at a Fermilab workshop on silicon detectors (Ferbel and Kalbfleisch) in October 1981, we applied to join the embryonic SLD Collaboration. But what happened to the ‘drinking straw’? Backgrounds in SLC, encountered by Mark II, were much higher than expected**

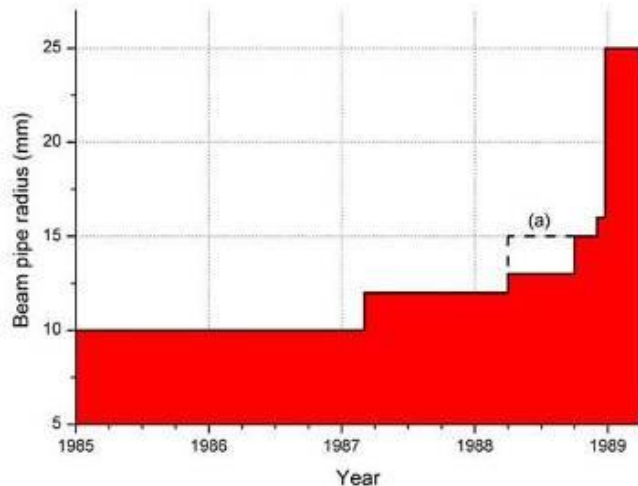

**SLD Advisory Gp Mtg Feb 1989:
“480 CCDs is ridiculous!”**



SLC, the fourth 'good idea' for the SLAC machine, hosted the world's first pixel-based vertex detector at a collider as a late entry, thanks largely to Marty Breidenbach

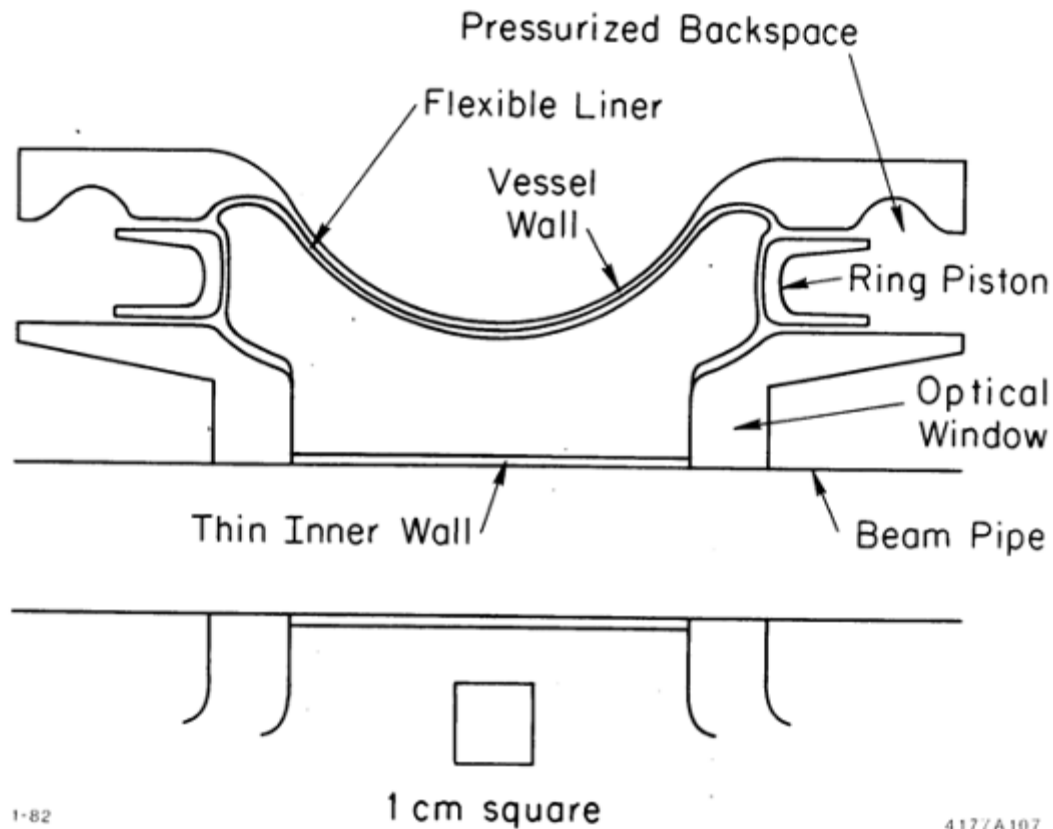
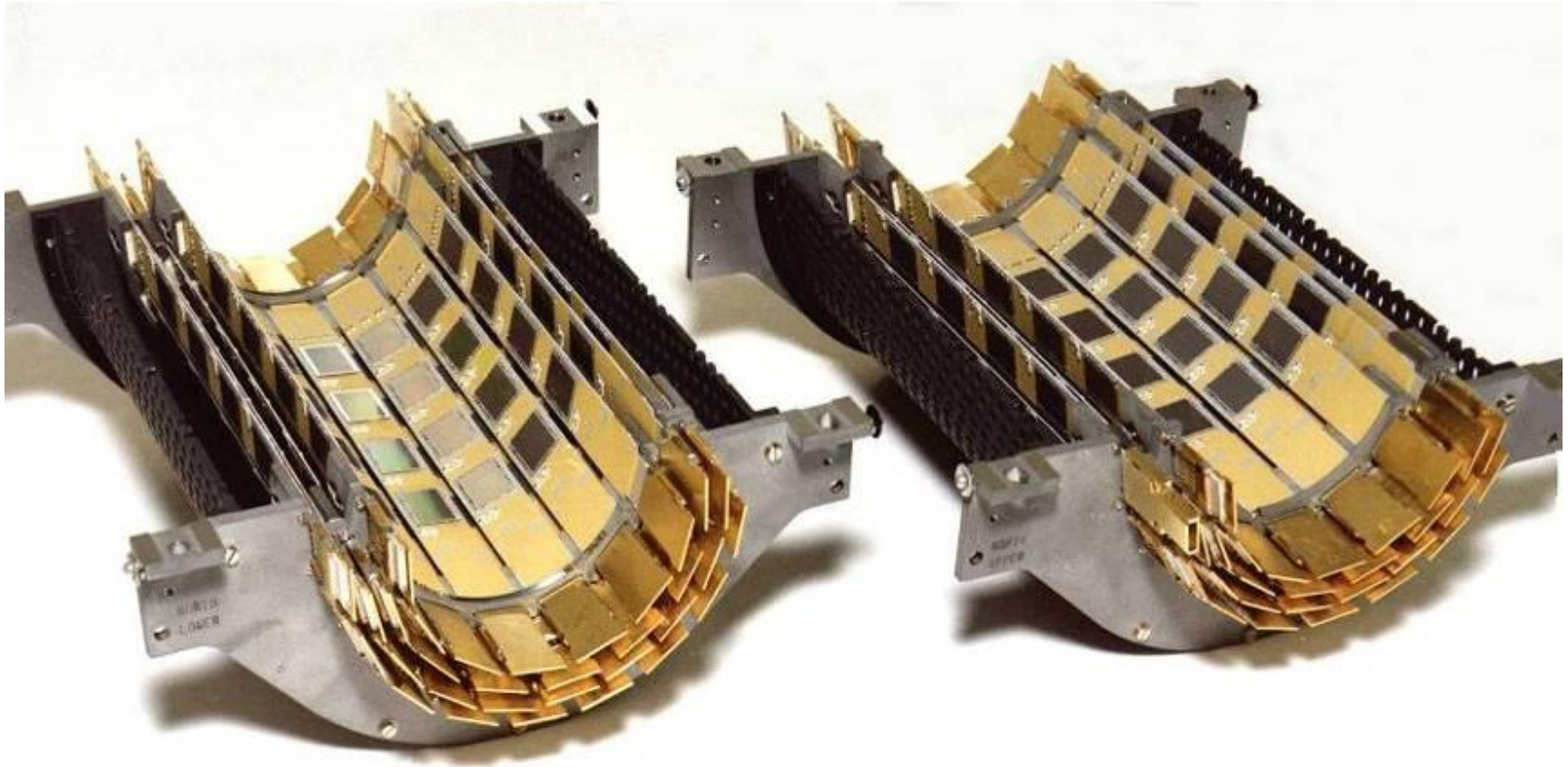

Fig. 7. Conceptual design of a propane bubble chamber vertex detector.

SLC Experiments Workshop 1982, a year after that Fermilab workshop on silicon detectors, and just 8 years before startup of SLD. Silicon was not even mentioned



VXD2 was laboriously built with 480 postage-stamp sized CCDs. It miraculously survived an incident when, after a fire in a damping ring, SLC was operated with an undamped electron beam, causing severe radiation damage ... Cooling it to 170 degrees K restored it to life



VXD2's polar angle coverage and tracking lever arm were limited. But it worked well enough to do some fine physics and establish the potential for an upgrade, using state-of-art CCDs

VXD3 upgrade detector

Proposed at Collab mtg in Saratoga, 1992

Su Dong: **'That's the vertex detector I joined SLD to build'**

Increased from 0.25 to 3.2 Mpixels per device

Increased from 120 to 307 Mpixels, allowing 3 well-spaced layers and full polar angle coverage

Layer thickness 0.4% X_0

Removed *a ton* of cables due to local data processing and fibre-optic signal transmission

VXD3 was built quickly and installed in 1995

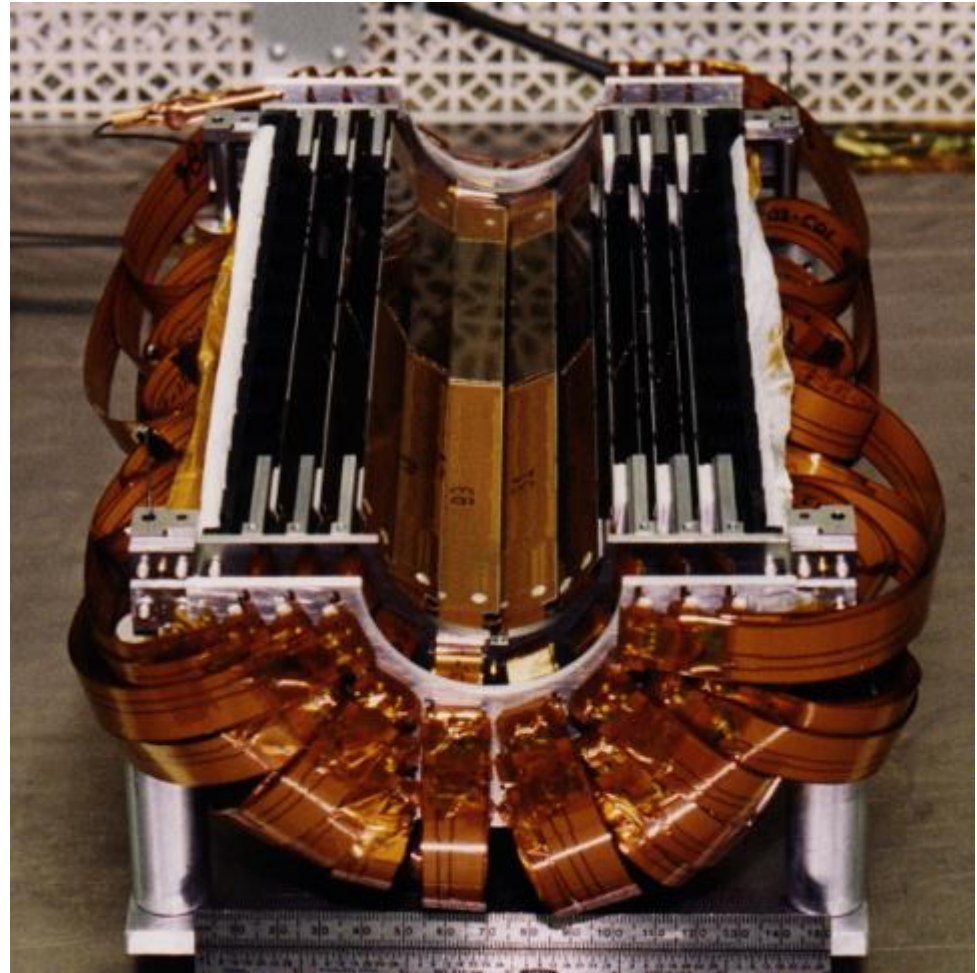



24th August 2016

RAL PPD seminar Chris Damerell

19

Run 33544, EVENT 6476
27-APR-1996 06:05
Source: Run Data Pol: R
Trigger: Energy CDC Hadron
Beam Crossing 1215252296

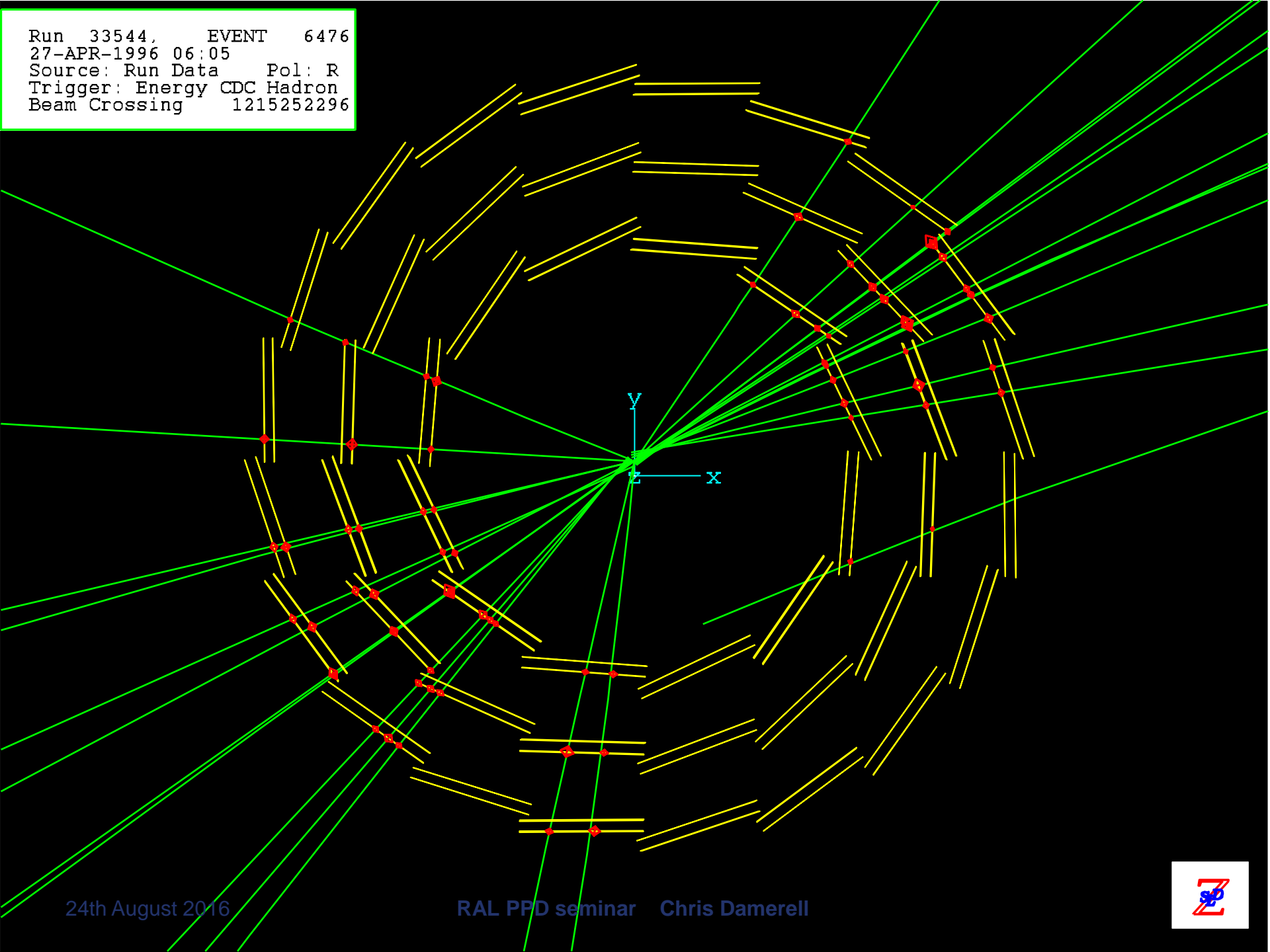

Run 33544, EVENT 6476
27-APR-1996 06:05
Source: Run Data Pol: R
Trigger: Energy CDC Hadron
Beam Crossing 1215252296

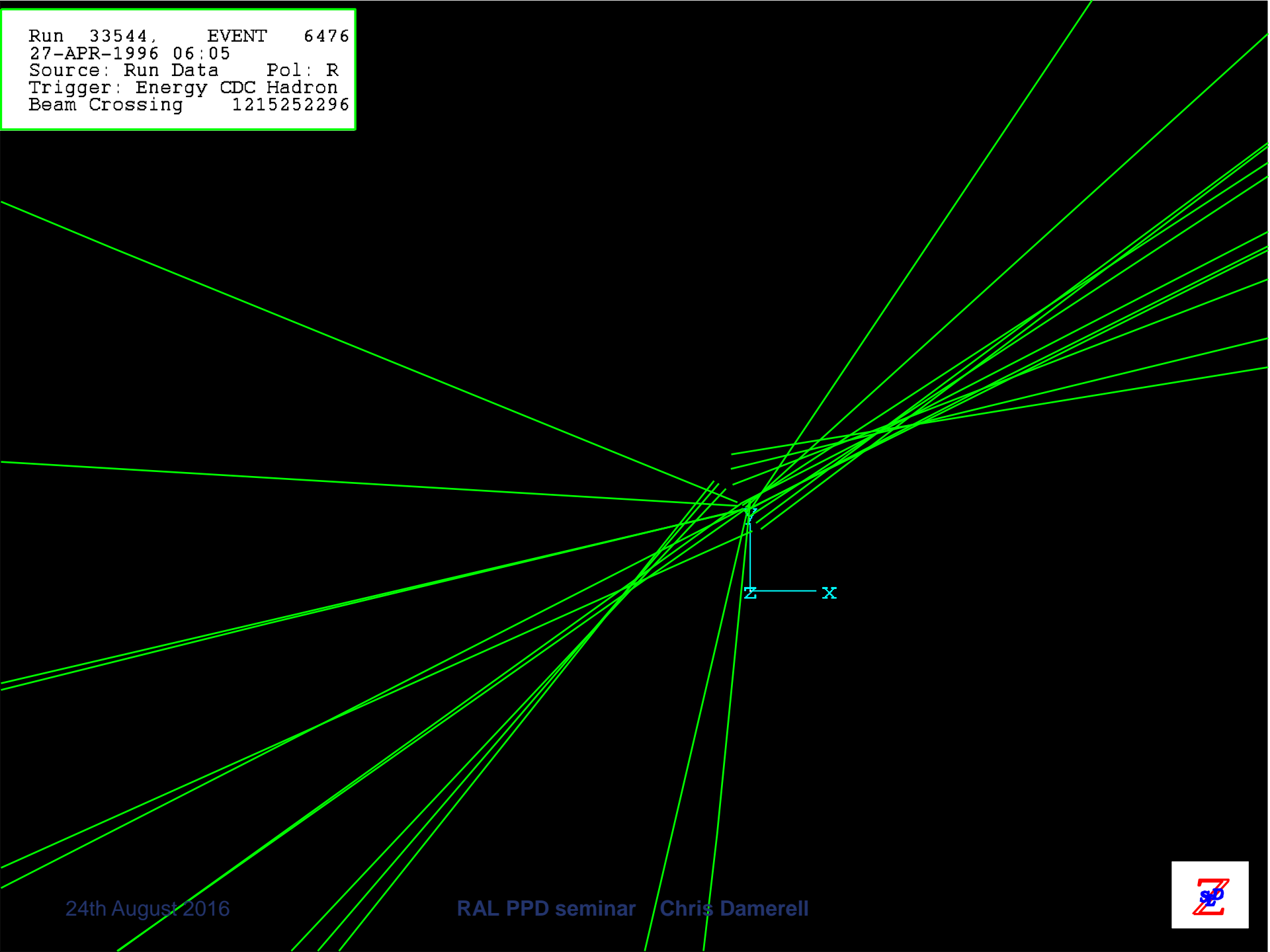

- The finely segmented SLD vertex detector was extremely robust, even in sometimes high background conditions (unlike its predecessor, Mark II's microstrip detector, which frequently 'brought SLC to its knees')
- It immediately established **(and still holds)** the world record for performance (in terms of impact parameter precision as function of momentum) and hence delivered far more heavy flavour physics per event than was possible at LEP
- **The longitudinally polarised electron beam plus our vertex detector were a winning combination.** We accumulated only 1/30 of LEP data, but made world's best measurements for charged and neutral B lifetimes, R_b , $A_{FB}(b)$ $A_{FB}(c)$, B_d and B_s mixing .. For B_s mixing, a hot topic, it took 10 years for CDF to overtake SLD.

- Due to its special features, some of us believe that the time has come for the monolithic pixel technology to move into the arena of overall tracking systems. We started serious studies in this direction for ILC, following the Tracking Detector Review of 2007 in Beijing, at which the shortcomings of the existing design concepts became apparent. Our ideas were first presented in 2008 at the ILC workshop in Sendai, by Konstantin Stefanov.

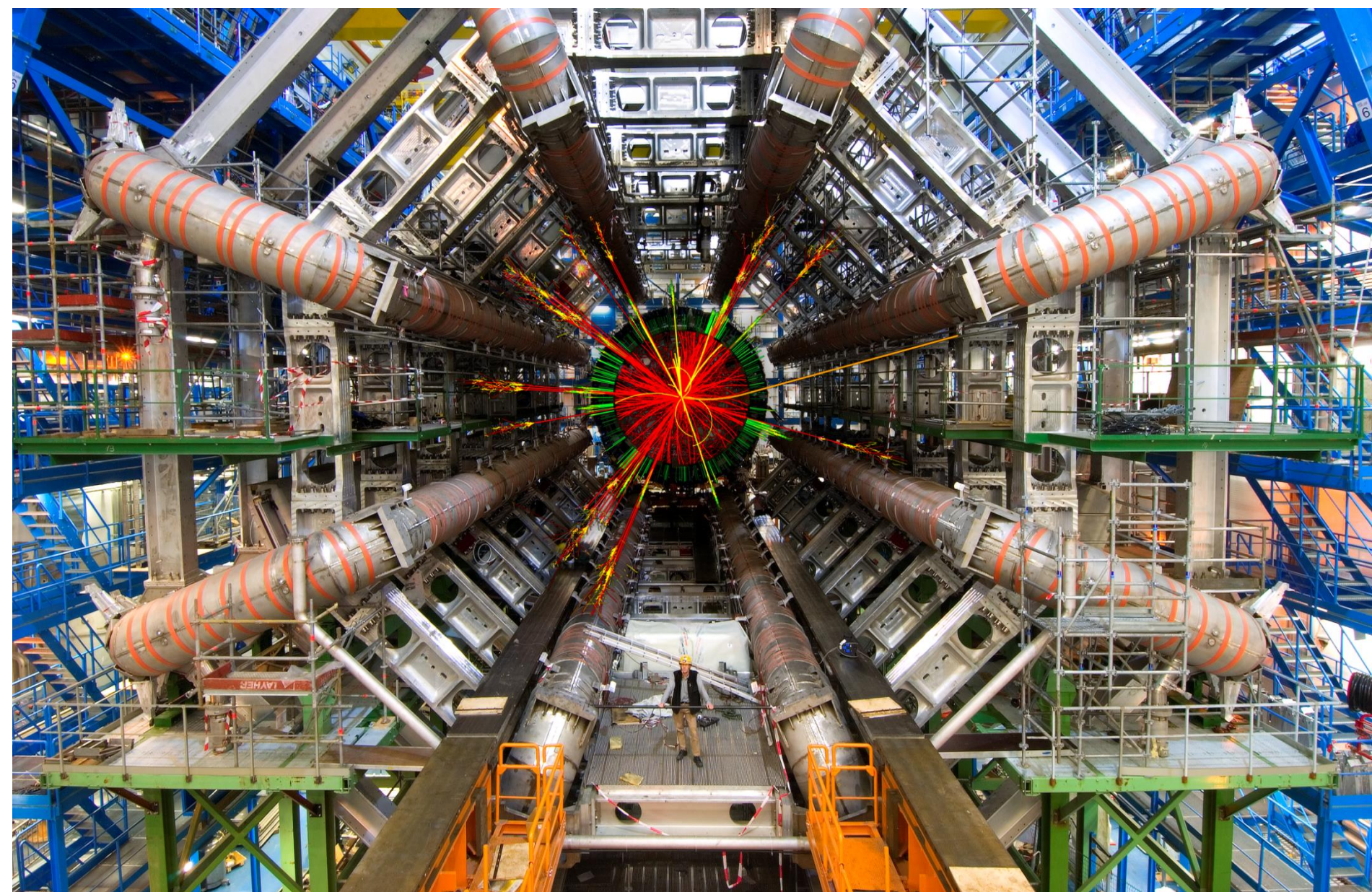

We are all full of admiration for the power and beauty of the LHC detectors, but they do have some important deficiencies...

24th August 2016

RAL PPD seminar Chris Damerell

23

Lessons from LHC (ATLAS)

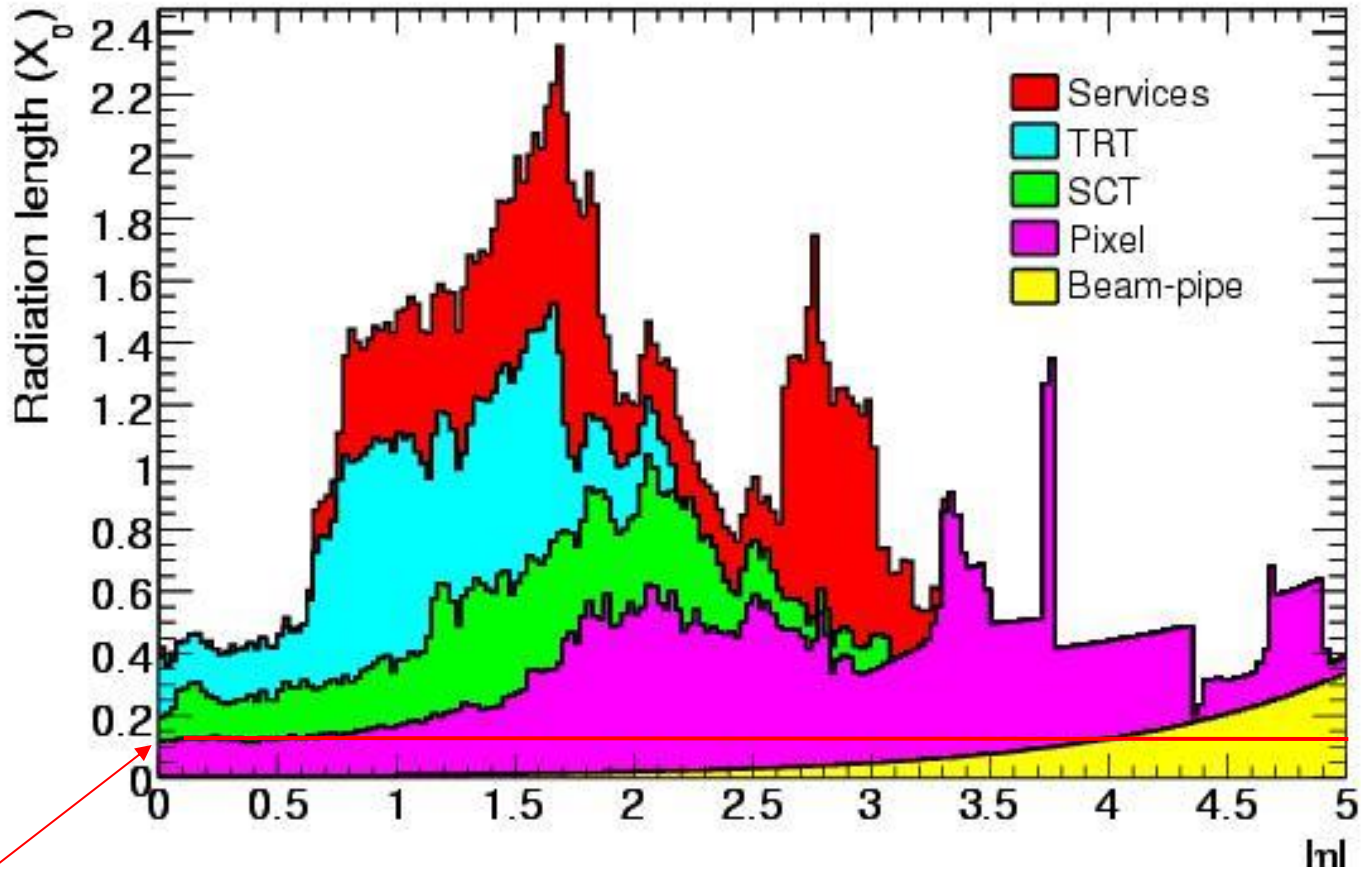

10% X_0 , a frequently-suggested goal for the ILC/CLIC tracking systems

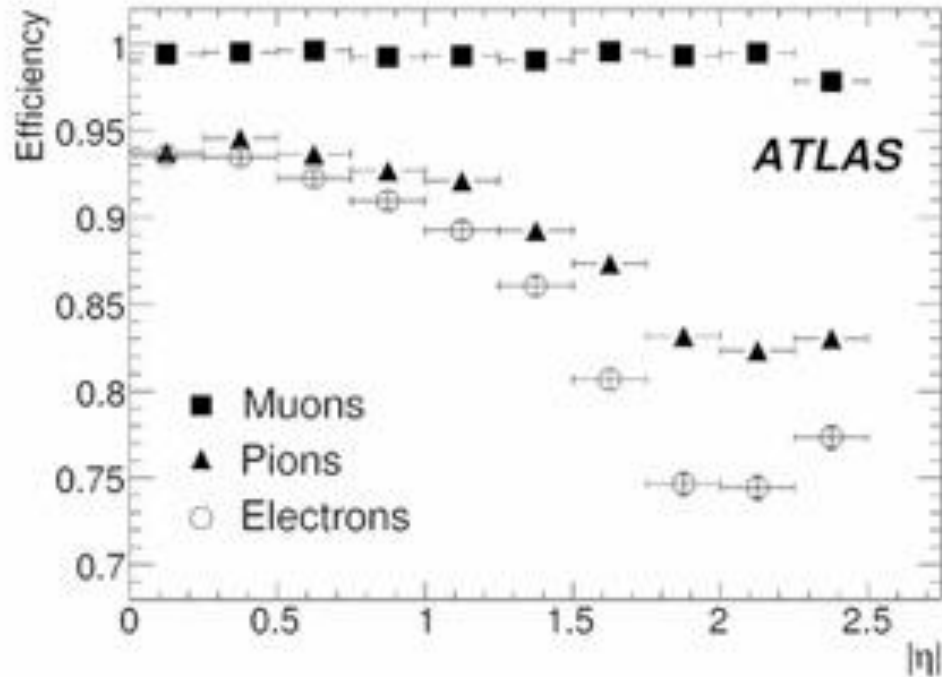

Plot shown by Markus Elsing at Vertex 2011 workshop

Pions have almost as much trouble ploughing through the material as do electrons

Forward tracking is particularly in need of help. Marcel Demarteau – 'Tracking has always gone to Hell in the forward direction'

Silicon Pixel Tracker Design Concept

- How to overcome the apparent fatal defect that a pixel detector has ~1000 times more channels than microstrips, hence excessive power dissipation?
- **Basic SPT concept is a ‘separated function’ design – precision timing on every track *but not on every point on the track*. So we suggest an optimised mix of tracking layers and timing layers, with only the latter having single-bunch timing precision**
- **It is furthermore suggested is to discard the tracking layer data for all except high momentum tracks, which are identified by the timing layer information**
- Furthermore, thin CMOS pixels can offer a different ‘*separated function*’ feature – evading* the link between charge collection and charge sensing, stipulated by Veljko Radeka’s ‘*capacitance matching theorem*’, with major advantages in terms of power dissipation and noise performance. This ‘evasion’ has been widely exploited in silicon imaging devices for photon science and astronomy (the so-called 4T or charge-coupled CMOS pixels)

By using a *monolithic silicon architecture* the system will be readily scalable by 2025 to the level of ~40 Gpixels. (whereas with hybrid pixels, this might be prohibitive)

* *Veljko is delighted about this!*

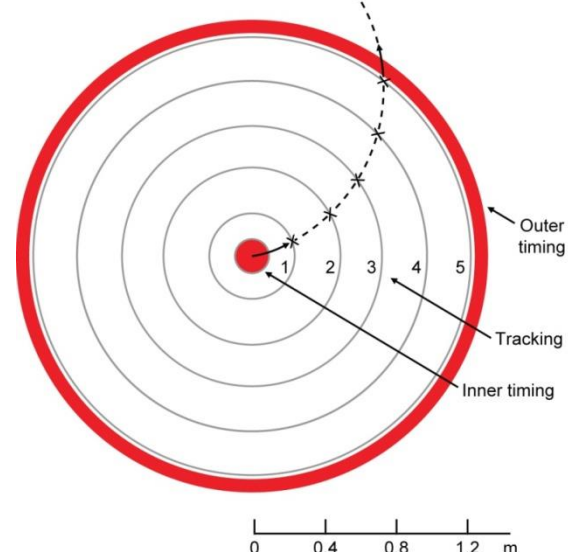
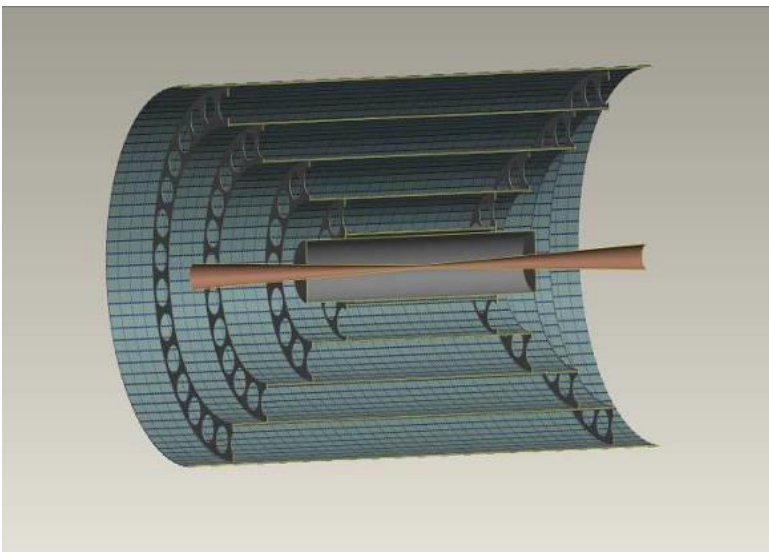

- **Barrels:** mechanical supports made of SiC foam ladders, with sensors glued to the outer faces. Rigidity by sparse foam links between ladders
 - **Tracking layers:** 5 cylinders, $\sim 0.6\% X_0$ per layer, $3.0\% X_0$ total, over full polar angle range $\sim 50 \mu\text{m}$ square pixels **GAS-cooled**
 - **Outer timing layers:** ~ 3 cylinders as an envelope, $\sim 2\% X_0$ per layer $\sim 150 \mu\text{m}$ square pixels **Evaporative CO₂ cooling**
- **Endcaps:** 8 matching layers, closing off each of the nested barrels
 - **TOTAL TRACKER MATERIAL $\sim 9\% X_0$, plus the usual obliquity factors**
- Tracking layers are read out for high- P_T tracks only, between bunch trains (5 Hz or 50 Hz for ILC or CLIC)
- **This study was put on hold in 2008 after STFC 'ceased investment' in ILC, but has been revived by the LCUK Tracking Collaboration ably led by Joel Goldstein**

Growth of CCD mosaics

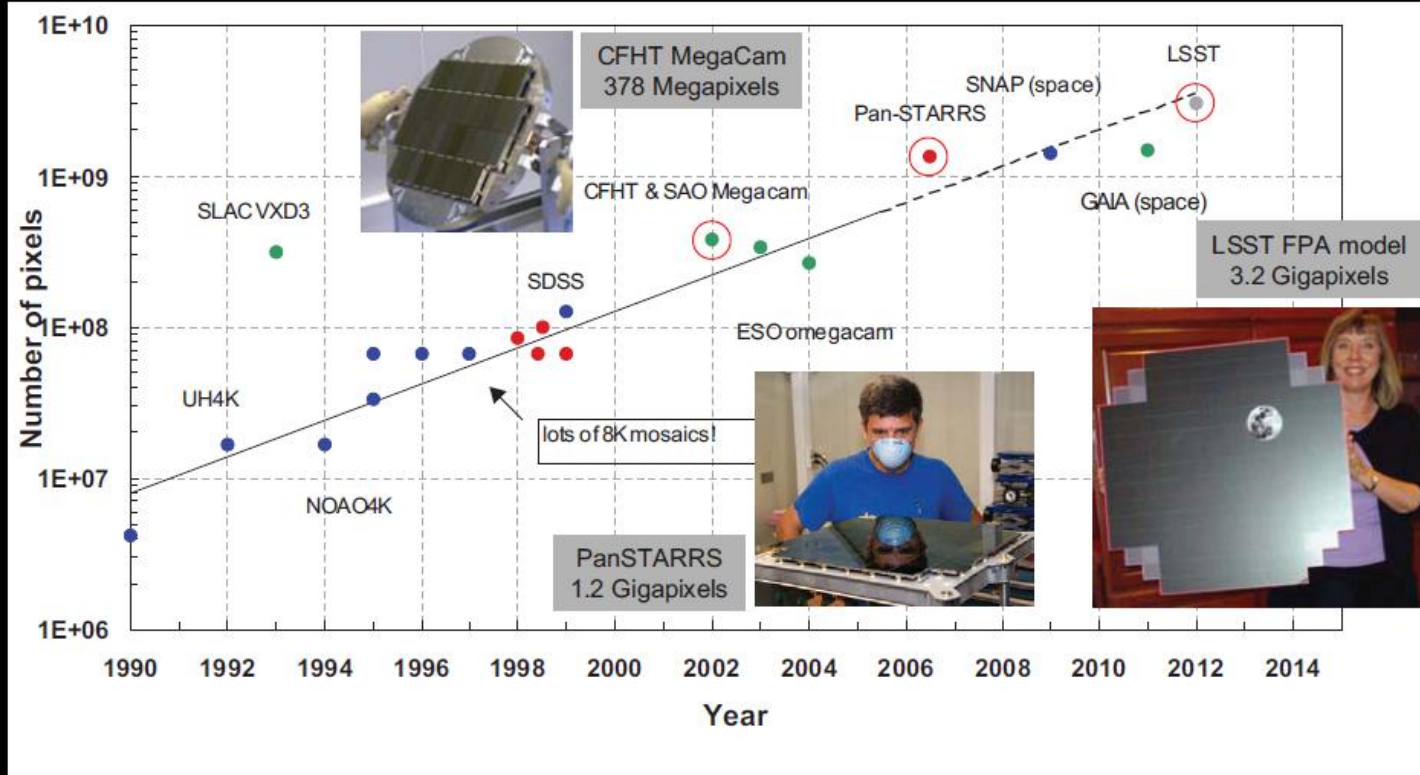
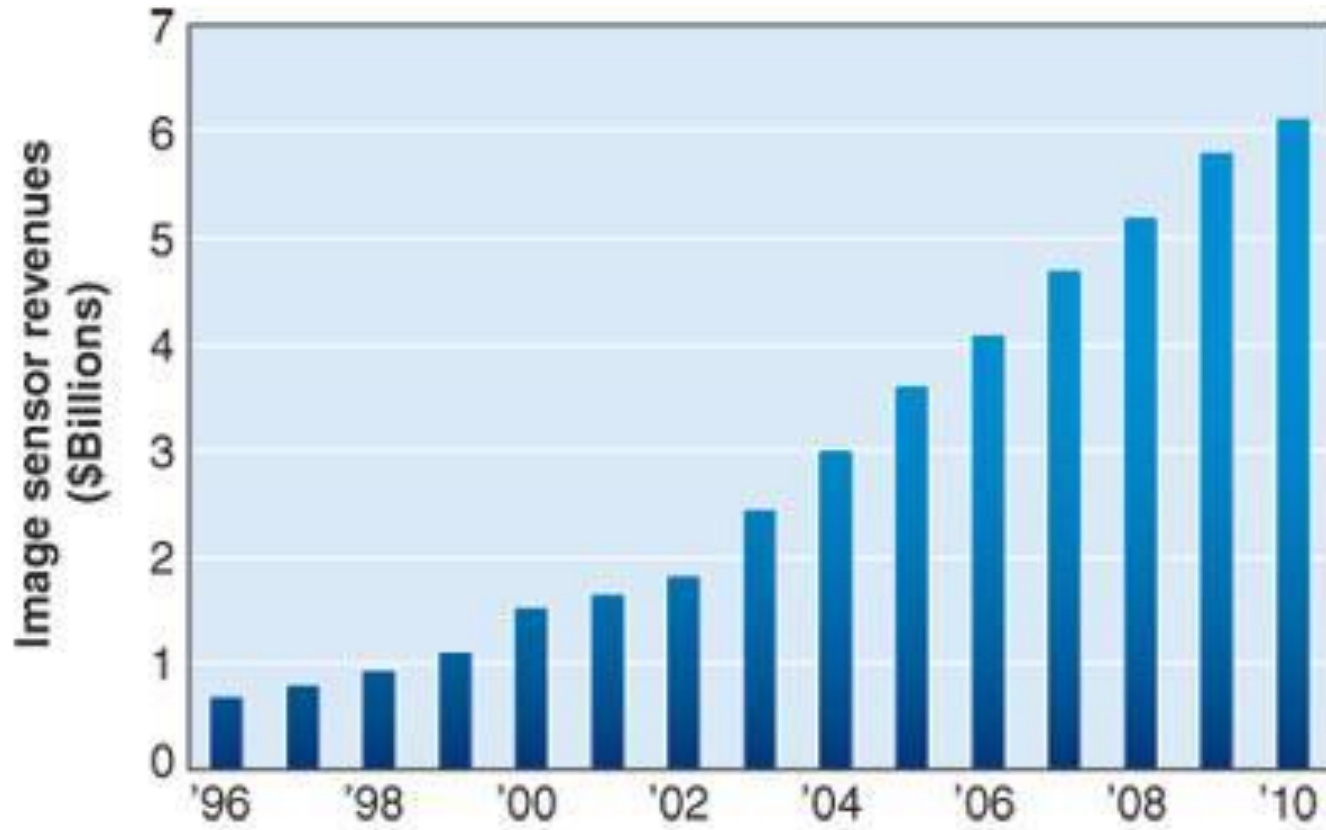

Illustration of large focal plane sizes, from Luppino 'Moore's' law

Focal plane size doubles every 2.5 years



Eric Fossum’s talk at Snowmass 2000 “There is one thing stronger than all the armies in the world; and that is an idea whose time has come”

Branching out ...

- 4th generation X-ray sources (currently LCLS at SLAC, and the European XFEL coming soon, with more being planned) offer a factor $\sim 10^6$ in brightness compared with 3rd generation machines such as Diamond
- For **molecular biology**, a major problem is the inability to grow large crystals for X-ray diffraction
- This enhanced brightness permits diffraction patterns to be obtained from crystallites (already established at LCLS) and even potentially from 'single particles', provided the problems of coulomb explosion and S/N ratio can be overcome – looking good
- The detector challenges are severe, due to the combined requirements of pixel size ($\sim 80 \mu\text{m}$), ADC resolution (16 bits), and readout rate (**at least 10 kframes/s**), in a harsh radiation environment. Fortunately, we have a very talented group from RAL, Oxford U and Open U with new ideas to achieve these goals
- As well, we are interested in another blossoming field – **super-resolution microscopy**, which has at least 1000 researchers distributed in the Oxford area alone. Some of the technical challenges are similar, and may also benefit from our new approach

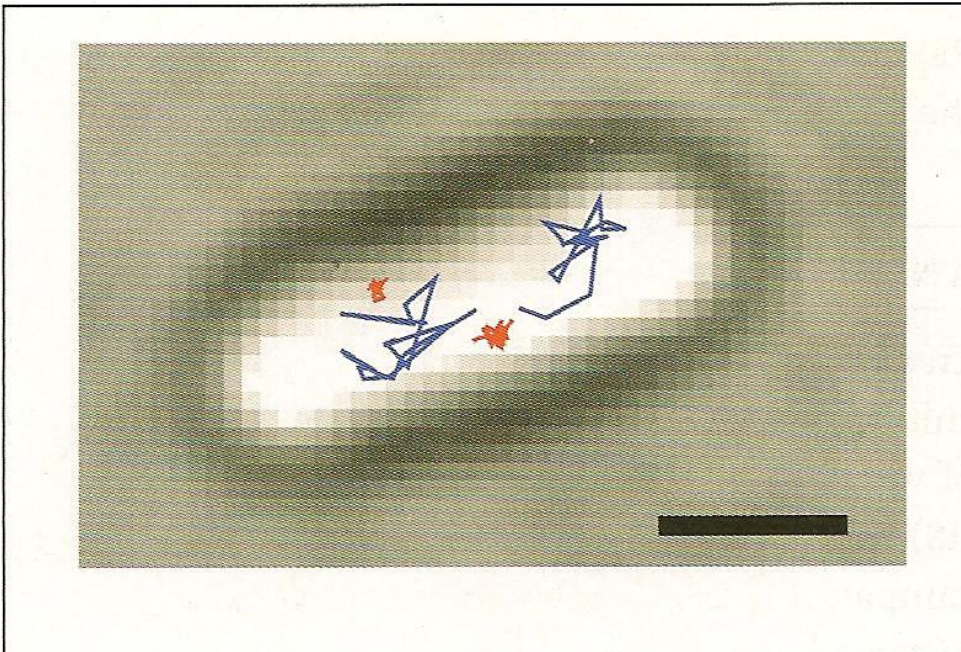

DNA polymerase molecules tagged

**Tracking precision ~10 nm
ie 0.01 μm**

average repair time = 2.1 s

**Achillefs Kanapidis,
Physics Dept, Oxford U, 2015**



Real photons – closely related!

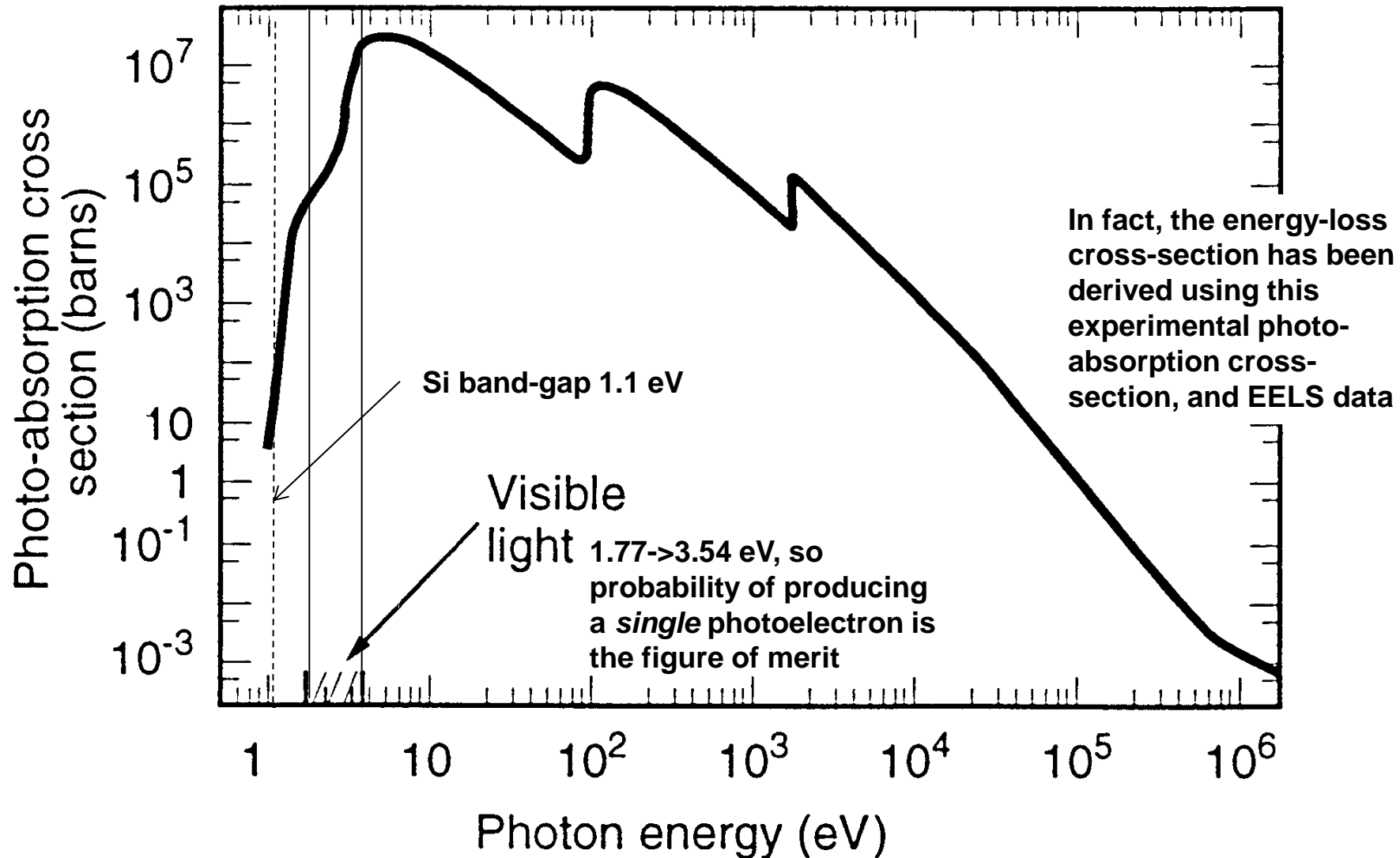

Since ~1970, the 'hunting tool' at the high energy frontier has become exclusively the 4-pi general purpose detector (GPD). Contrast the discoveries made and missed at SPEAR Mark I Detector and the multitude of 'special purpose' detectors at the CERN ISR.

GPDs are 'hermetic'. They include a solenoid magnet, tracking and calorimetry (with sometimes PID, TRT, muon tracking add-ons, as occasional visitors).

Since the time of SLD (late 1980s), all GPDs have striven to include vertex detectors for b-tagging and if possible also charm tagging. Lessons were learned from experiments that omitted or had second-rate vertex detectors.

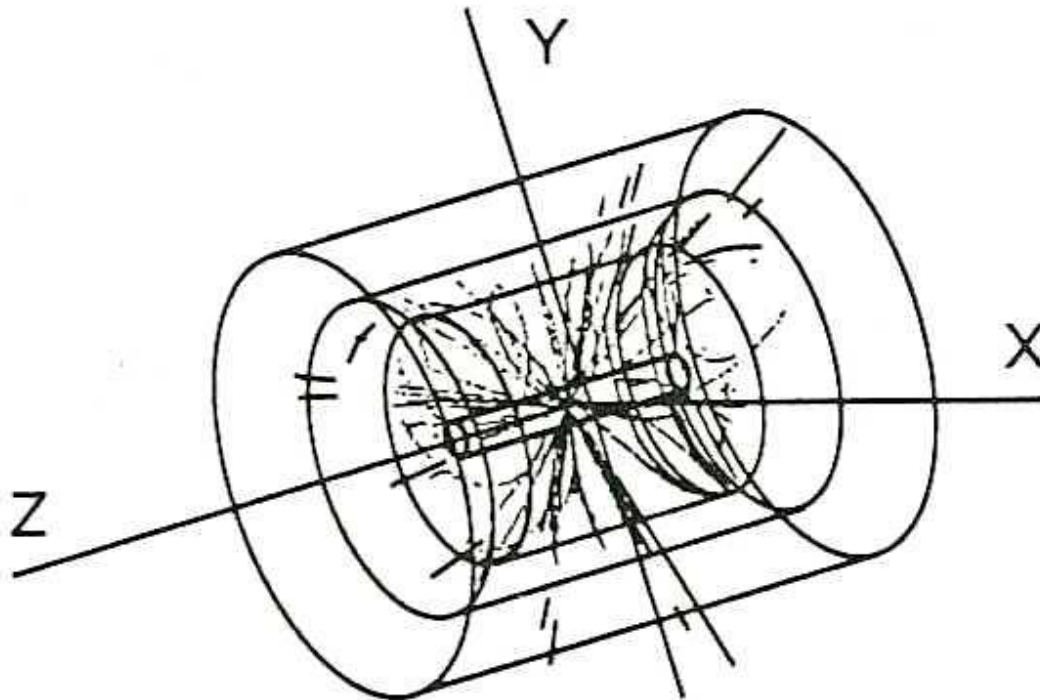

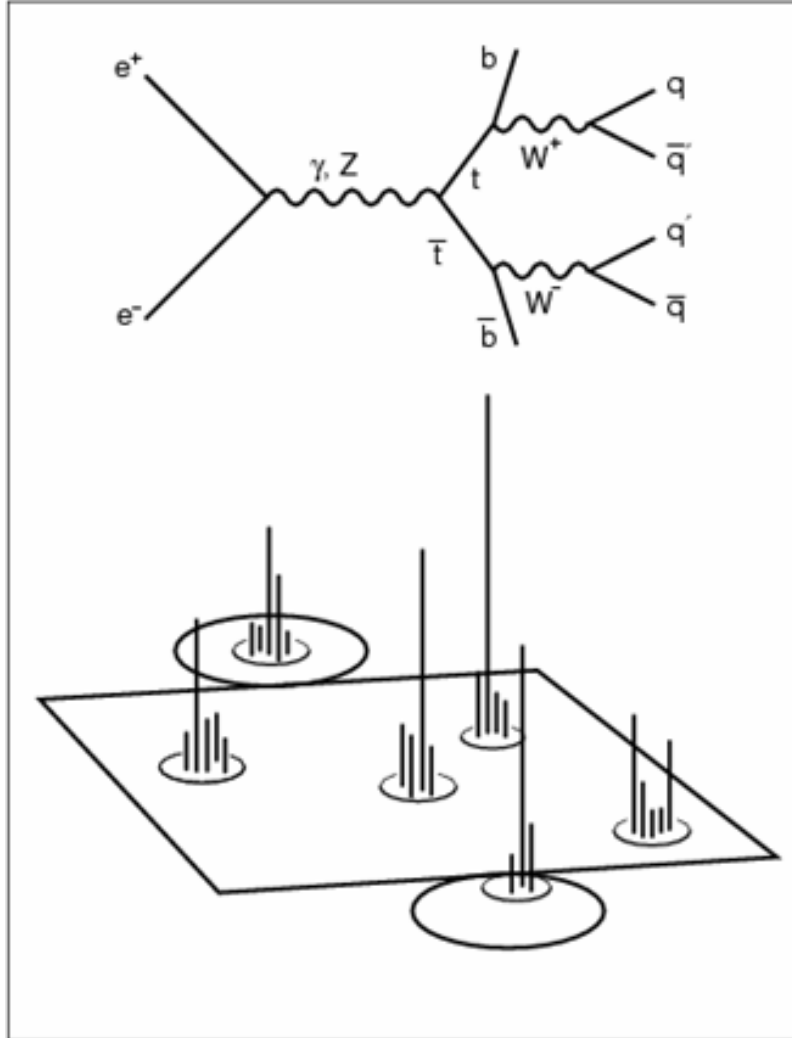

The miracle of PFA (or equivalent jet energy resolution) reveals the flow of energy from the quarks of the primary interaction

However, this is still not enough information for full physics analysis ..

Need to tag the heavy flavour (b and c) jets, and for some essential physics to distinguish between the quark and anti-quark jet

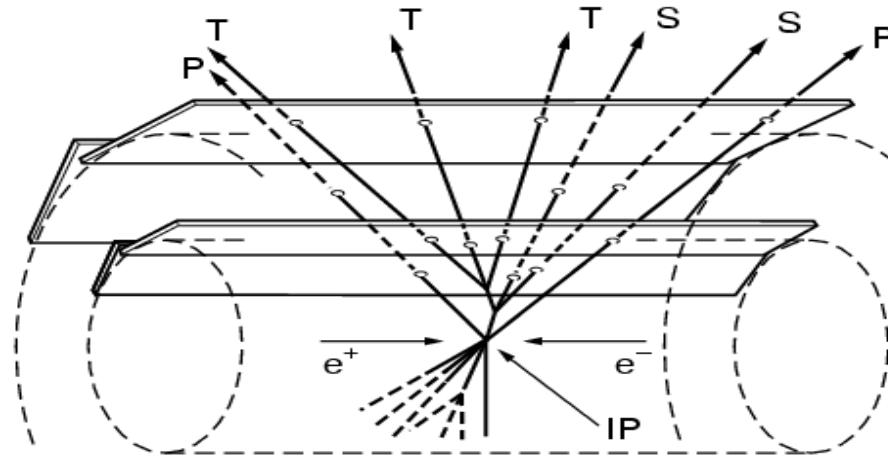

In general, minimise R_{BP} . But considerations of background usually push one away

If the vertex tree is not resolved, there is no way to recover this information

Why silicon for vertex/tracking detectors?

- As recently as 1975 (ie *after* discovery of J/ψ), there was little interest in tracking detectors with precision better than $\sim 100 \mu\text{m}$ (Charpak at EPS Conference in Palermo)
- **A condensed medium** is obligatory for precision < 10 microns (diffusion of electron cloud in **gaseous detectors** typically limits precision to tens of microns)
- Liquids? Argon and xenon had been tried in the early 70's but there were impurity issues, affecting electron lifetime. Also, needs containers, not good for tracking
- Silicon band gap of 1.1 eV is 'just right'. Silicon delivers ~ 80 electron-hole pairs per micron of track, but kT at room temperature is only 0.026 eV, so dark current generation is modest, often negligible even without cooling
- Silicon has low Z (hence minimal multiple scattering) and excellent mechanical properties (high elastic modulus). Ideal for tracking detectors with minimal material budget
- Silicon is *THE* basic material of microelectronics, giving it unique advantages. Hybrid devices are acceptable in form of microstrips or large pads, but for pixel devices with possibly billions of channels, the monolithic architecture is highly desirable, and far cheaper. On-detector data sparsification may almost eliminate cabling – **mechanics, cabling and cooling are more damaging to the material budget than thin detectors**

Energy loss of min-I particles in Si

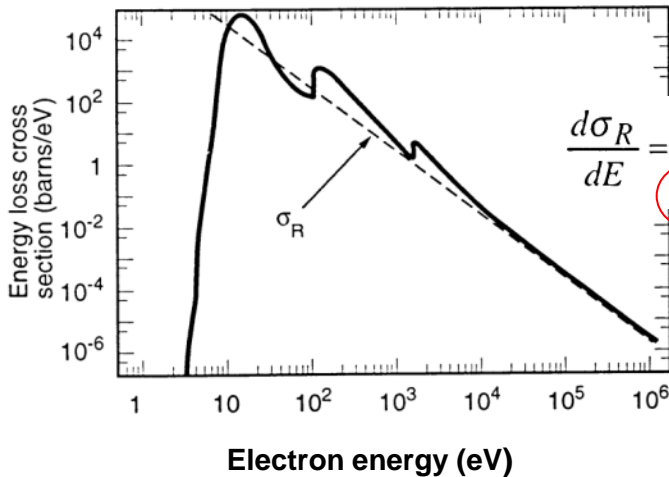

$$\frac{d\sigma_R}{dE} = \frac{2\pi q_e^4}{m_e c^2 \beta^2} \times \frac{1}{E^2}$$

Nuclei are relevant for multiple scattering, but not for energy loss

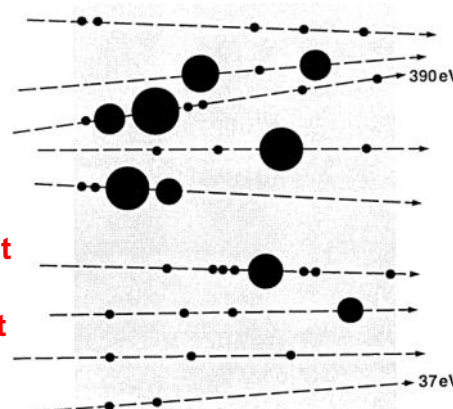

Energy deposited by min-I particles traversing 1 μm thick Si detector (Monte Carlo). Size of blob represents energy deposited, all within $<1 \mu\text{m}$ of track

- Rutherford cross-section (which assumes atomic electrons to be free) does well except for distant collisions, where the atomic binding inhibits energy loss
- K- and L-shell electrons are liberated by hard collisions, for which the atomic binding is barely relevant
- M-shell (valence) electrons are excited *collectively* forming 17eV plasmons. These induce a cutoff in cross-section for which the classical model has to impose a semi-empirical threshold
- All these primary ionisation products lose energy partly by electron-hole (e-h) generation, and partly by thermal excitation and excitation of optical phonons.
- Si band-gap is 1.1 eV, but on average 3.6 eV is required to generate an e-h pair, so 'efficiency' for energy loss by ionisation is ~30%
- This 'pair creation energy' W depends weakly on temperature (increases by 4% from room temp down to 80K), but otherwise it applies over a wide range of excitations, including high energy particles, x-rays and UV photons. For visible light, it's of course different ...

One plasmon of 17 eV

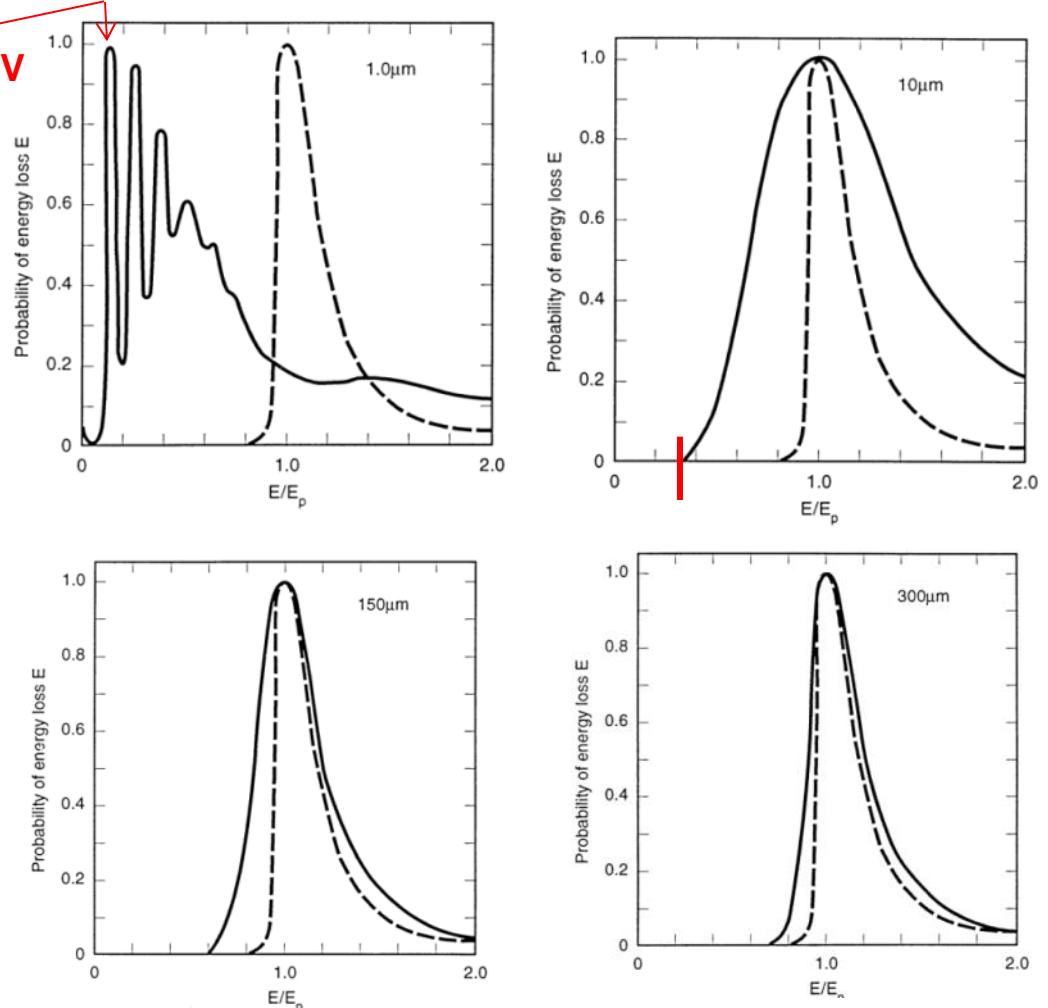

- For thin active layers of silicon, the deviation of the energy-loss distribution from Landau is dramatic. Even for 10-20 micron thickness, need to be careful with noise performance/threshold settings in order to achieve efficient min-I detection

Electrons

Collision probability per micron

K (2)

8.8×10^{-3}

L (8)

0.63

M (4)

3.2

Total: 3.8 primary collisions / μm

- For precise track reconstruction, it is desirable to **minimise the active thickness** of silicon, hence the probability that fluctuations in energy loss can seriously pull the position of the reconstructed cluster in the detector plane
- In principle this can be avoided by excluding the tails with large energy loss (if it is measured) but one usually lacks the required level of redundancy in detector planes
- **New development: Hans Bichsel's code, via Su Dong, is now implemented in ATLAS tracking, and shows significant differences wrt the simplified Geant-4 code. Hopefully, it will be included as an option in Geant in the near-term future.**

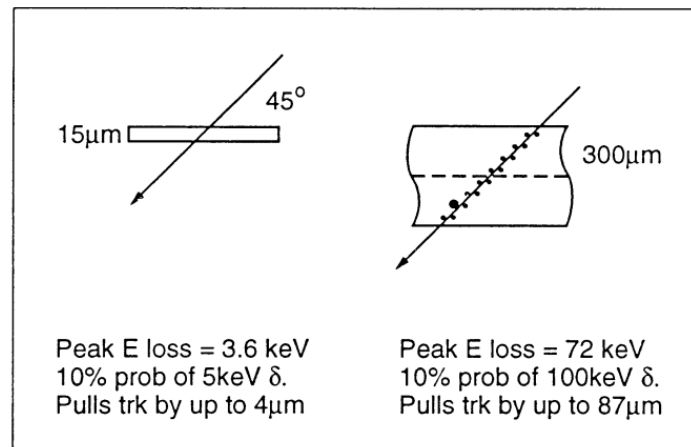

Rutherford High Energy laboratory, SPSC
2 Feb 1970

Liquid-filled Wire Chambers

Because of diffusion effects (and other effects dependent on the mode of use) gas filled chambers (spark chambers or proportional wire chambers) are limited in resolution to a few tenths of a millimetre.

The Alvarez group has recently² observed electron multiplication in liquid argon. This opens the way for an improvement in precision of 2 orders of magnitude; resolution of $\sim 5\mu$ becomes a reasonable possibility.

- **By 1972, there were serious doubts about the Bootstrap Theory. Furthermore it was clear that we could not muster the necessary resources, so we teamed up with the CERN-Munich Group with a more modest goal: to ‘think what we could do at the SPS with their existing PS spectrometer’**
- **All thoughts of high-precision tracking detectors were shelved, for the time being ...**
- **Thus ACCMOR, one of the most productive collaborations in particle physics, was born, to study multi-pion resonances and other slightly stale physics**
- **Meanwhile, events elsewhere (Bell Labs and SLAC) were shaping our futures**

ILC as an example

SiD tracker layout
(silicon microstrips).
Consider
implications of
switching to pixels ..

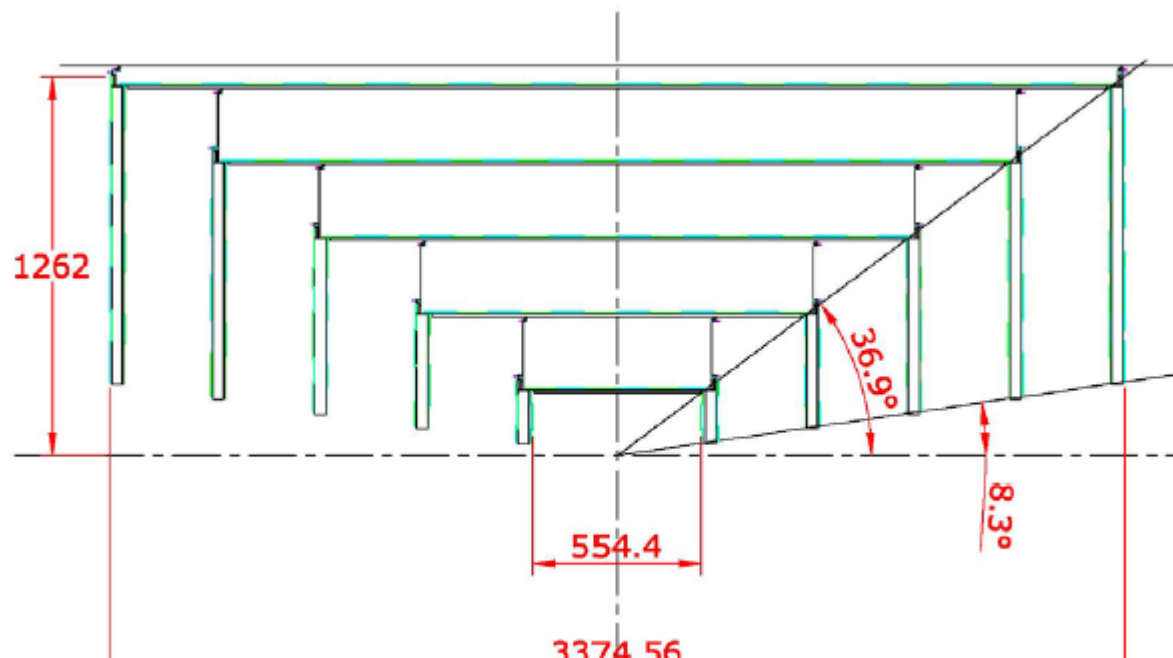

- 5 barrels and 4 endcaps, total area = **70 m²**
- Everyone accepts need for standalone trk finding in this subsystem
- With 50 μm square pixels – **28 Gpix system**
- Low mass support, gas cooling
- If each sensor is 8 cm \times 8 cm (2.6 Mpix): 11,000 sensors is total
- Forward disks may all need time stamping, due to high 2-photon bgd

Pixel-based vertex and tracking detectors - conclusions

- The history of pixel-based vertex detectors in particle physics, while dating back to 1980, was for 20 years limited to just two projects that did physics (ACCMOR and SLD). However, this has changed dramatically in recent years (ATLAS, CMS, ALICE, SuperBelle, STAR at RHIC, LHCb next, ...)
- For **Linear Collider vertexing**, there is no longer any debate. Unanimity was achieved at LCWS 1993 in Hawaii. Prior to that, microstrips ('good enough for LEP') were pushed by the majority
- For **Linear Collider tracking**, studies of a better alternative were launched as a result of the review of ILC Tracking Detectors in Feb 2007. While the Silicon Pixel Tracker (SPT) is not yet in anybody's baseline, it is being increasingly studied, primarily by the LCUK Tracking Collaboration
- A similar possibility could be investigated for **LHC tracking**, beyond the startup of the high luminosity running in about 2022
- The scale of such systems (~30 Gpixels) will be on Gerry Luppino's curve by about 2020. However, given the uncertainties, so some of us are helping to solve pressing problems of X-ray detection for 4th generation light sources, starting with LCLS-II

