



Gravitational Wave Searches - status and plans

Sheila Rowan for the LSC
Institute for Gravitational Research
University of Glasgow

RAL PPD Group

8th October 2008



G080565-00

Gravitation

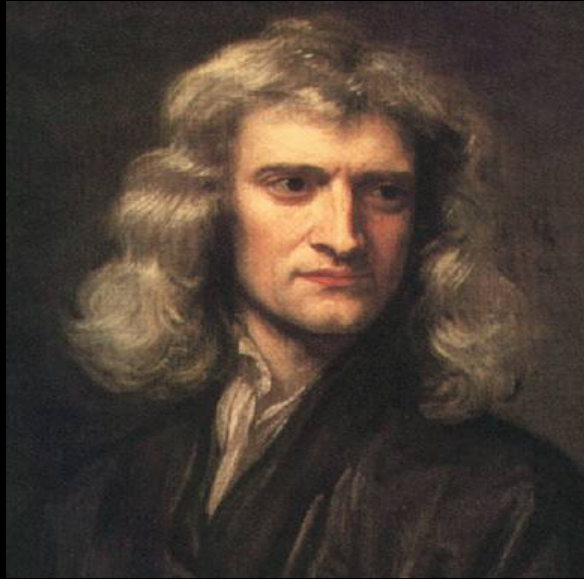

Newton's
Theory

*"instantaneous
action at a
distance"*

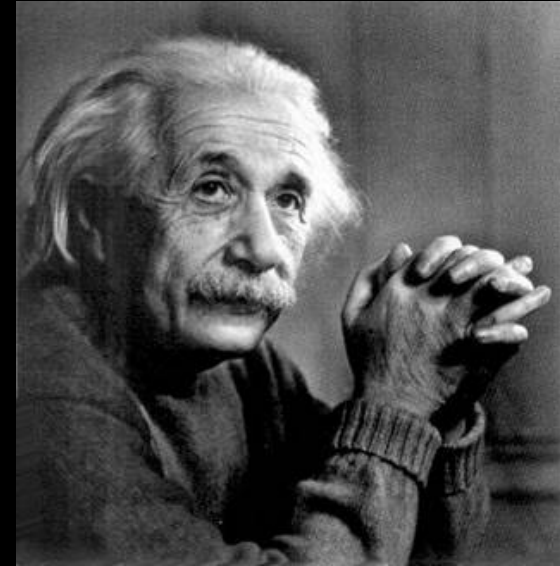

Einstein's Theory
*information cannot be
carried faster than
speed of light - there
must be gravitational
radiation*

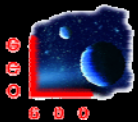

G080565-00



GW a prediction of General Relativity (1916)

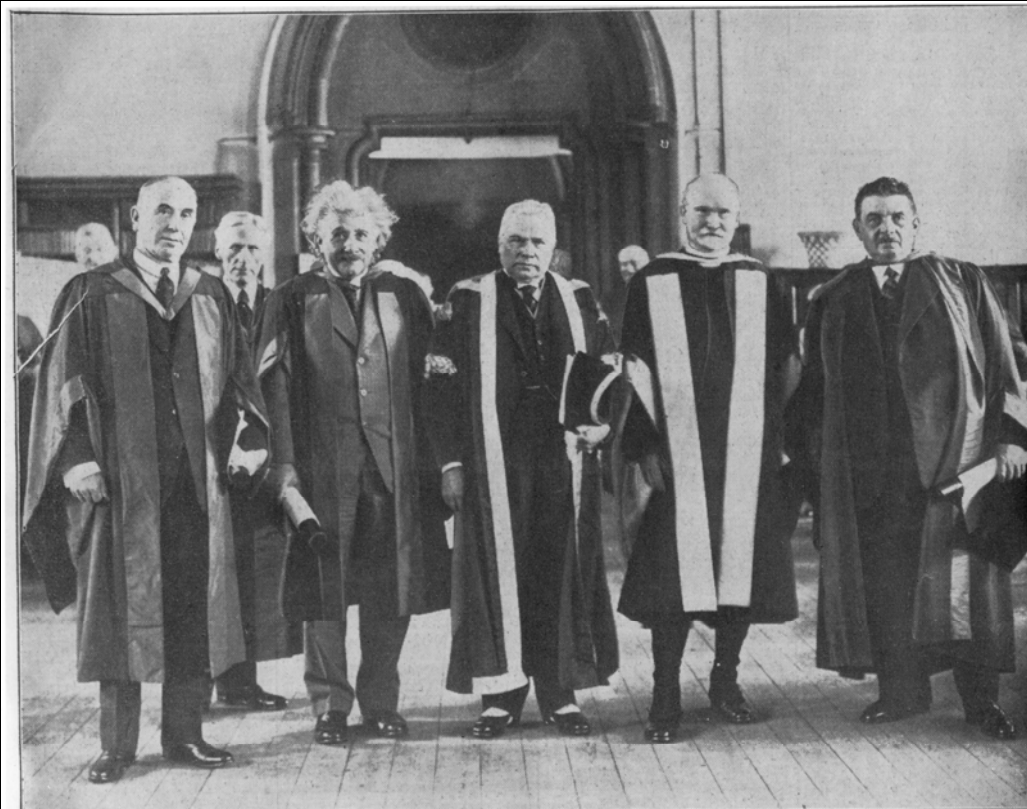

A group of some of the honorary graduates taken after the ceremony in the Butts Hall of Glasgow University yesterday. Left to right—The Right Hon. Sir Robert S. Horne; Emeritus Professor William Blair-Bell, University of Liverpool; Professor Albert Einstein; Principal Sir Robert S. Rait; the Archbishop of Armagh and Primate of All Ireland; and M. Edouard Herriot, former Prime Minister of France.

Einstein in Glasgow 1933

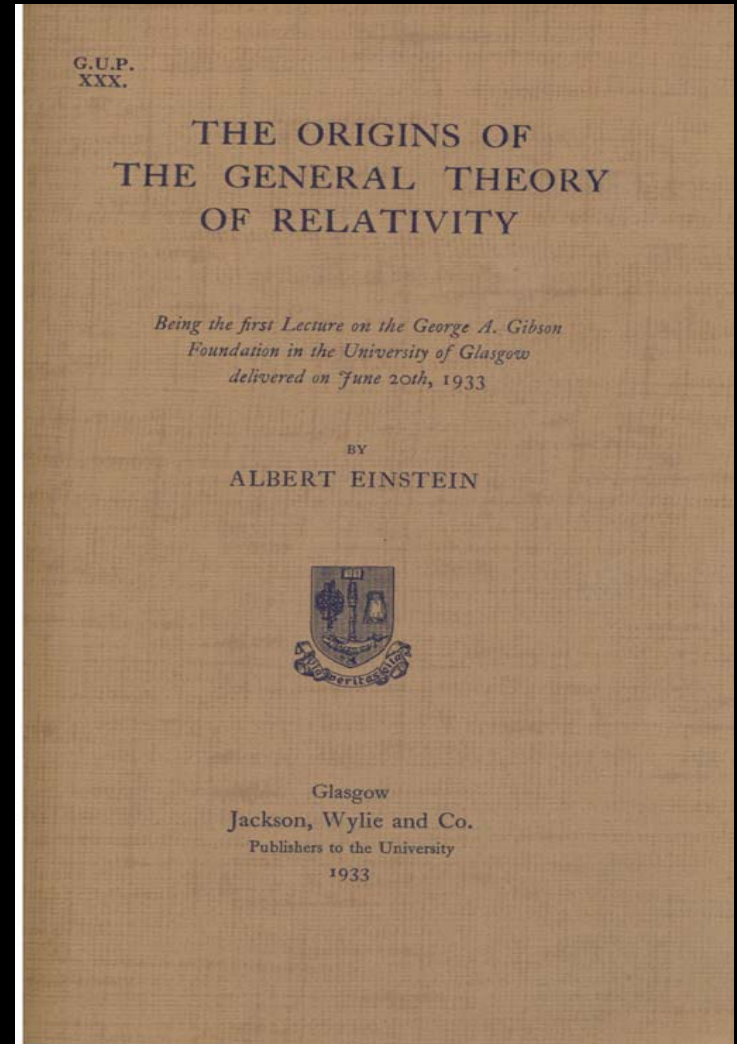

GW 'rediscovered' by Joseph Weber

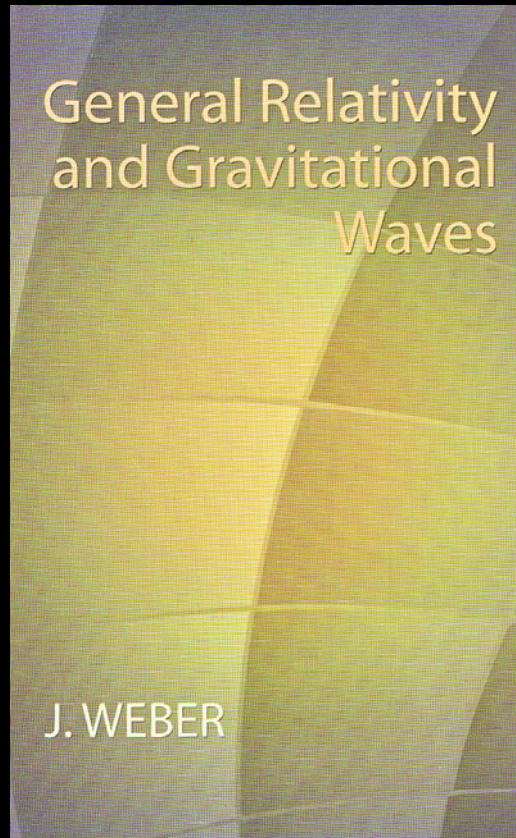

REVIEWS OF MODERN PHYSICS VOL. 29, # 3 JULY, 1957 509-515

Reality of the Cylindrical Gravitational Waves of Einstein and Rosen

JOSEPH WEBER, *Lorentz Institute, University of Leiden, Leiden, Netherlands,
and University of Maryland, College Park, Maryland*

JOHN A. WHEELER, *Lorentz Institute, University of Leiden, Leiden, Netherlands,
and Palmer Physical Laboratory, Princeton University, Princeton, New Jersey*

(1961)

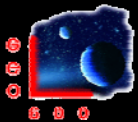

G080565-00



'Gravitational Waves'

- Produced by violent acceleration
 - neutron star binary coalescences
 - black hole formation and interactions
 - cosmic string vibrations in the early universe (?)
- and in less violent systems:
 - pulsars
 - binary stars
- Gravitational waves**
 - 'ripples in the curvature of spacetime' that carry information about changing gravitational fields - or fluctuating strains in space of amplitude h where: $h \sim \Delta L/L$

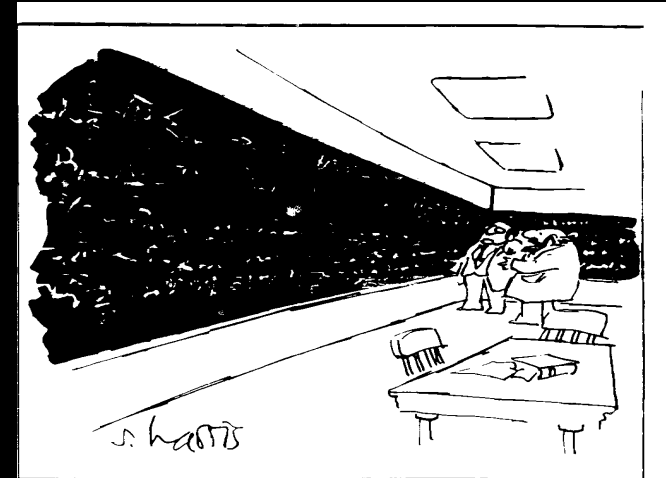

"But this is just a simplistic way of looking at the problem".
© 1989 by Sidney Harris

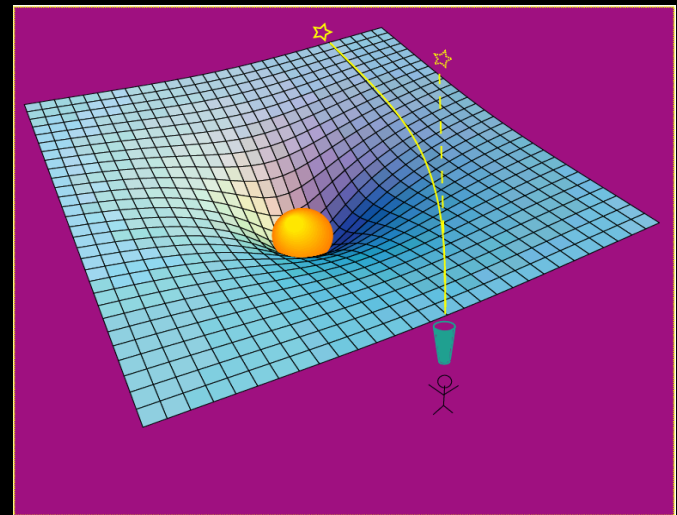

'Gravitational Waves' - possible sources

- **Pulsed**
Compact Binary Coalescences
NS/NS; NS/BH; BH/BH
Stellar Collapse (asymmetric) to NS or BH
- **Continuous Wave**
Pulsars
Low mass X-ray binaries (e.g. SCO X1)
Modes and Instabilities of Neutron Stars
- **Stochastic**
Inflation
Cosmic Strings



Binary stars coalescing



Supernovae

Detection of Gravitational waves – sources and science

- **WHY?** - obtain information about astrophysical events obtainable in no other way
 - **Fundamental Physics**
 - test Einstein's quadrupole formula in the strong field regime using binary inspirals
 - test Einstein's theory from network measurements of polarisation
 - confirm the speed of gravitational waves with coincident EM/GW observations
 - **Astrophysics: (Advanced interferometers)**
 - provide links to γ -ray bursts by detecting NS-NS, NS-BH binaries
 - take a census of BHs by detecting 100's of BBH from cosmological distances
 - detect radiation from LMXB's
 - Measure NS normal modes; probe glitches in pulsars
 - **Cosmology and Fundamental Physics**
 - Inform studies of dark energy
 - obtain accurate luminosity-distance Vs. red-shift relationship from inspirals from GW/EM observations
 - Detect possible GW background
 - **New Sources and Science:**
 - Intermediate Mass Binary Black Holes?
 - Burst of radiation from cosmic strings?
 - Backgrounds predicted by Brane-world scenarios?

B. Sathyaprakash

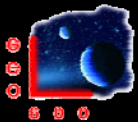

G080565-00



Sources - the gravitational wave spectrum

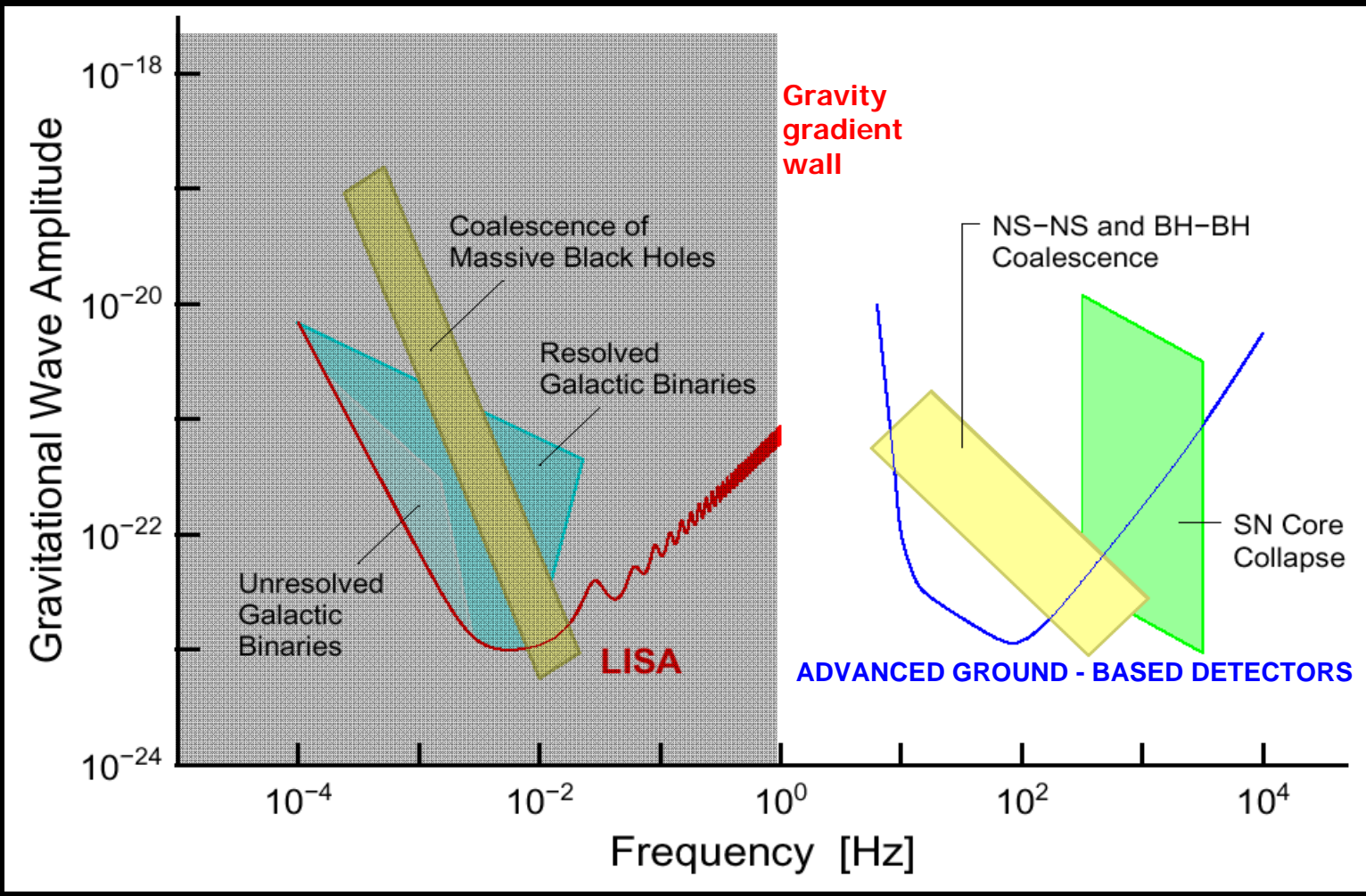

G080565-00



Evidence for gravitational waves

“Indirect”
detection
of gravitational waves

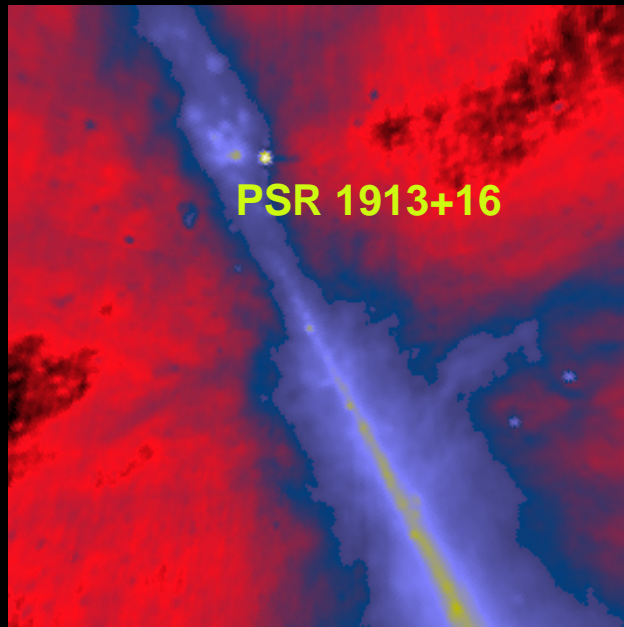

Comparison between observations of the binary pulsar PSR1913+16, and the prediction of general relativity based on loss of orbital energy via gravitational waves

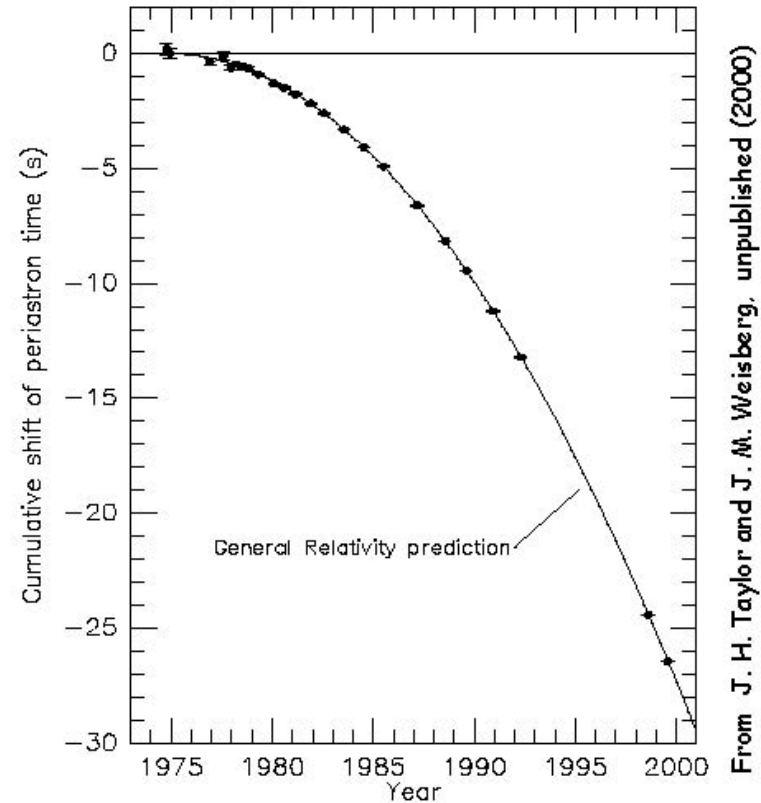

How can we detect them?

- Gravitational wave amplitude $h \sim \frac{\Delta L}{L}$

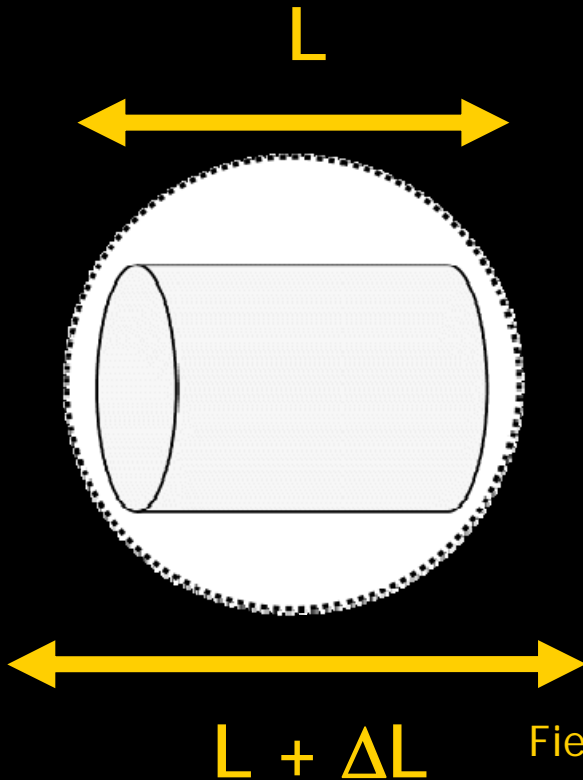

Sensing the induced excitations of a large bar is one way to measure this



VOLUME 22, NR 24 PHYSICAL REVIEW LETTERS 16 June 1969
 EVIDENCE FOR DISCOVERY OF GRAVITATIONAL RADIATION
 J. Weber
 (Received 29 April 1969)

Field originated with J. Weber looking for the effect of strains in space on aluminium bars at room temperature

Claim of coincident events between detectors at Argonne Lab and Maryland - subsequently shown to be false

Detection of Gravitational Waves

Consider the effect of a wave on a ring of particles :

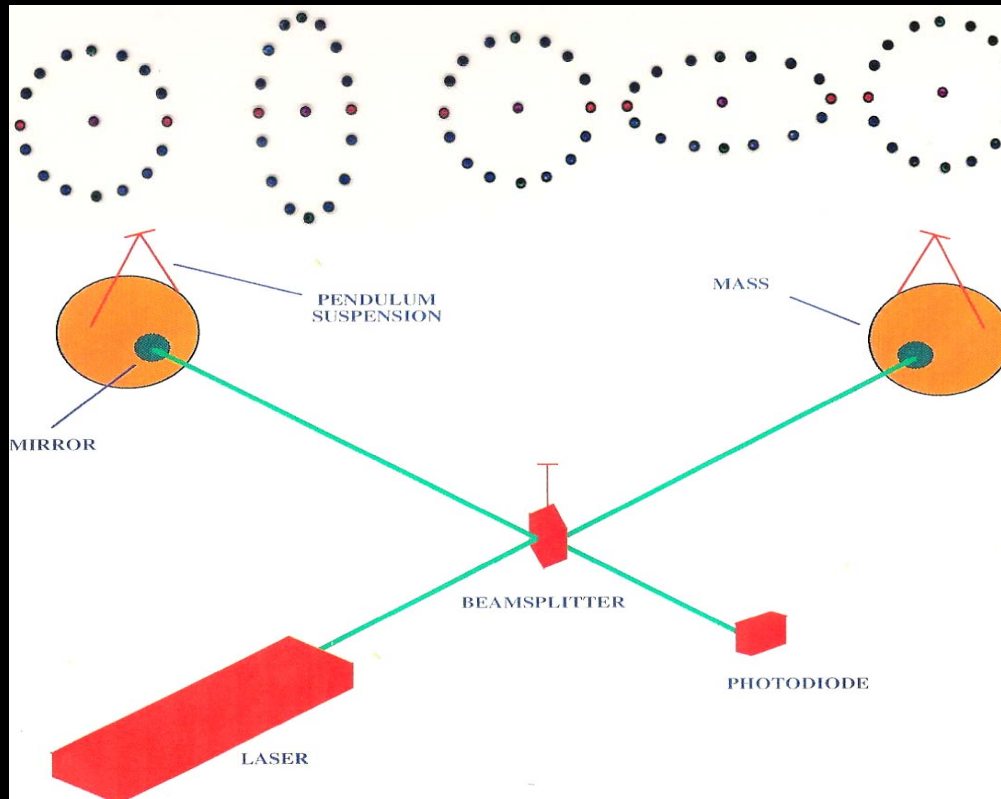

One cycle

Michelson Interferometer

Gravitational waves have very weak effect: Expect movements of less than 10^{-18} m over 4km

Principal limitations to sensitivity

- Photon shot noise (improves with increasing laser power) and radiation pressure (becomes worse with increasing laser power)

There is an optimum light power which gives the same limitation expected by application of the Heisenberg Uncertainty Principle - the 'Standard Quantum limit'

- Seismic noise (relatively easy to isolate against - use suspended test masses)
- Gravitational gradient noise, - particularly important at frequencies below ~10 Hz
- Thermal noise - (Brownian motion of test masses and suspensions)

All point to long arm lengths being desirable

- Several long baseline interferometers are now operating

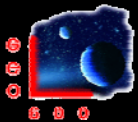

G080565-00



GW detector network

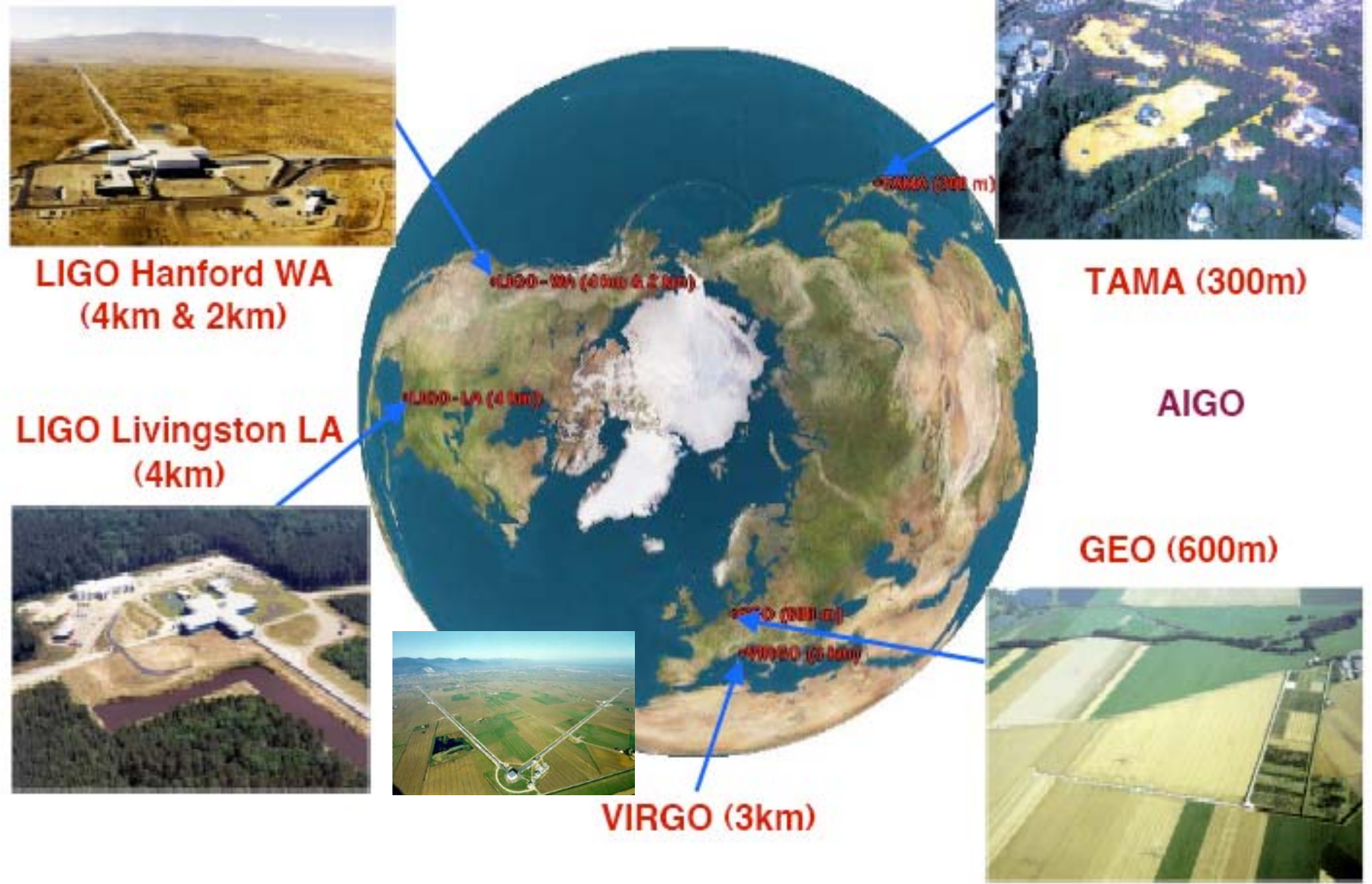

Initial LIGO detectors

LIGO project (USA)

- 2 detectors of 4km arm length + 1 detector of 2km arm length
- Washington State and Louisiana



Each detector is based on a 'Fabry-Perot - Michelson'

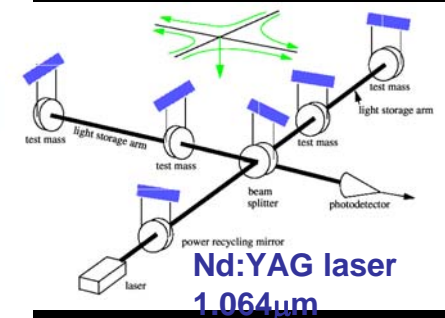

VIRGO: The French-Italian Project 3 km armlength at Cascina near Pisa



The 'Super Attenuator' filters the seismic noise above 4 Hz

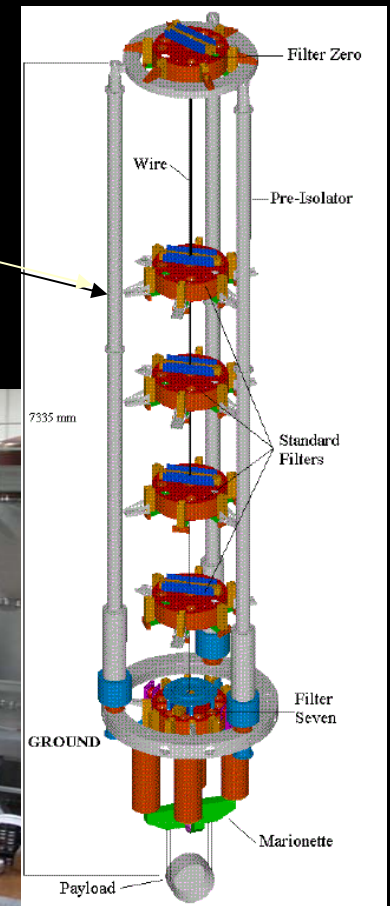

Other Detectors and Developments - TAMA 300 and AIGO



TAMA 300 Tokyo
300 m arms

AIGO Gingin, WA
80 m arm test
facility



UK-German collaboration:

- Univ. of Glasgow:
 - Hough, Rowan, Strain, Ward, Woan, Hammond, Heng, Robertson and colleagues
- Cardiff Univ.
 - Sathyaprakash, Schutz, Grishchuk, Sutton, Fairhurst and colleagues
- Univ. of Birmingham
 - Cruise, Vecchio, Freise and colleagues
- AEI Hannover and Golm
 - Danzmann, Schutz, Allen and colleagues
- Colleagues in Univ. de les Illes Balears

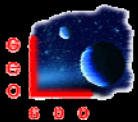

G080565-00



GEO 600

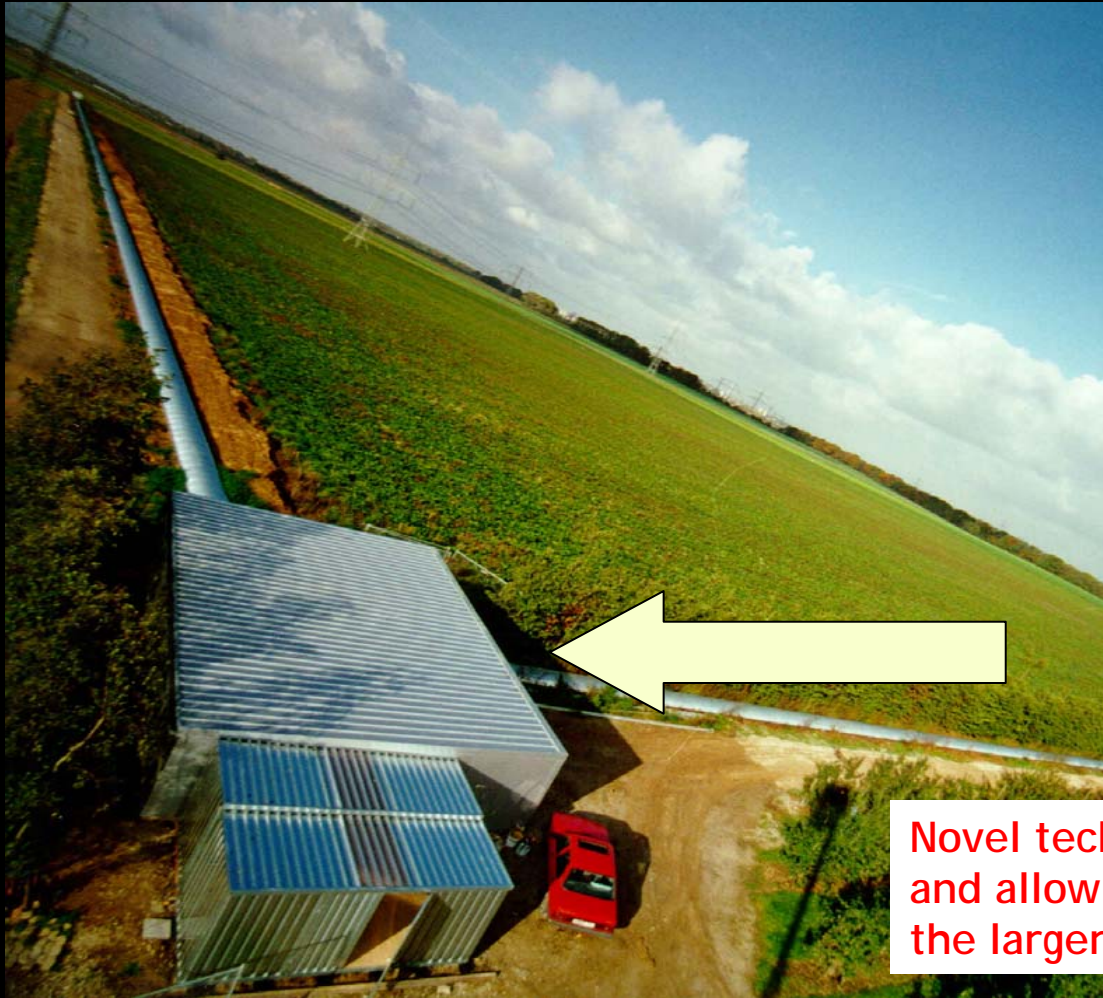

Novel technologies make GEO unique and allow it to run in coincidence with the larger LIGO (and Virgo) instruments

Gravitational Wave Network Sensitivity

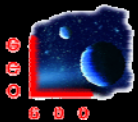
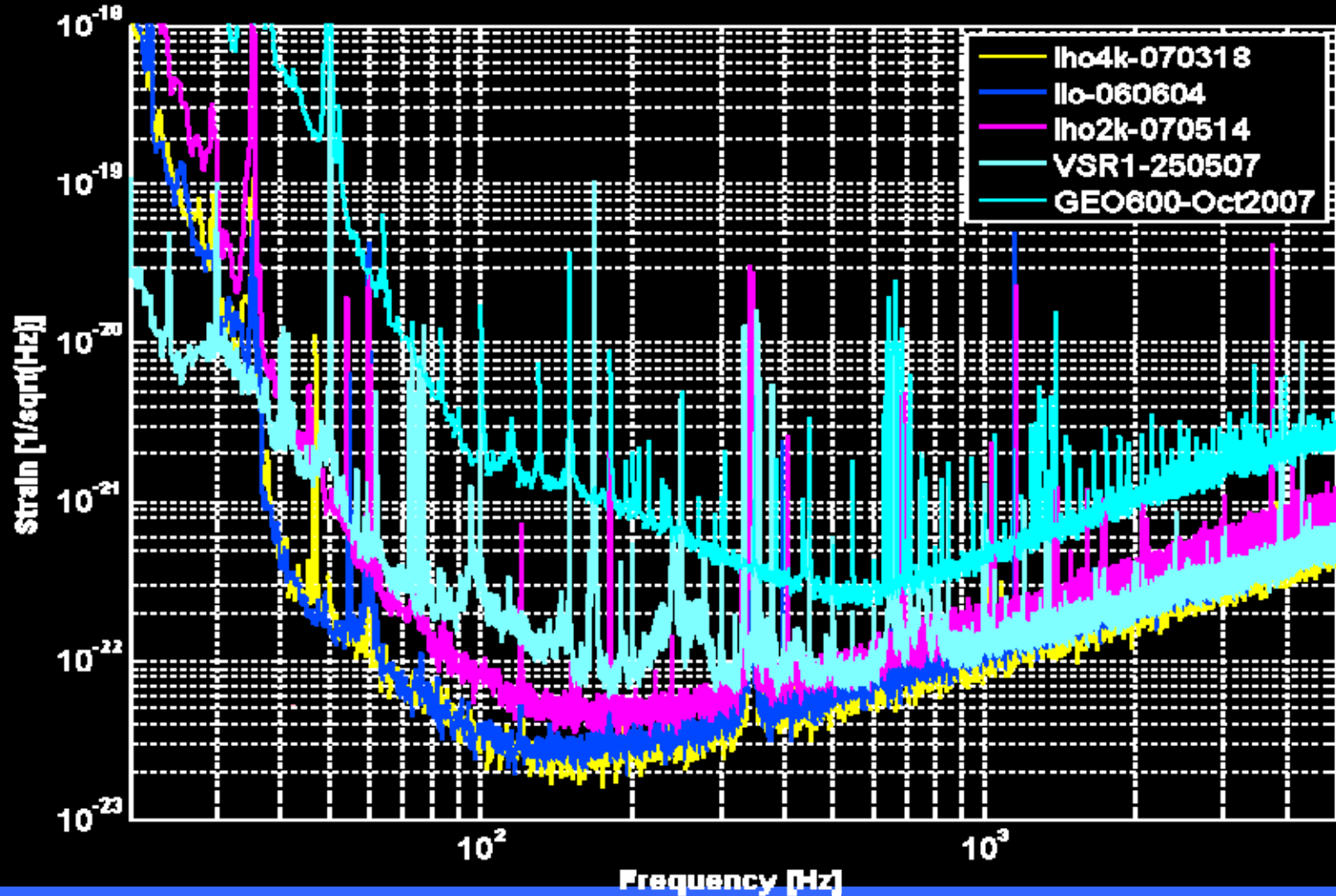

G080565-00



LIGO now at design sensitivity

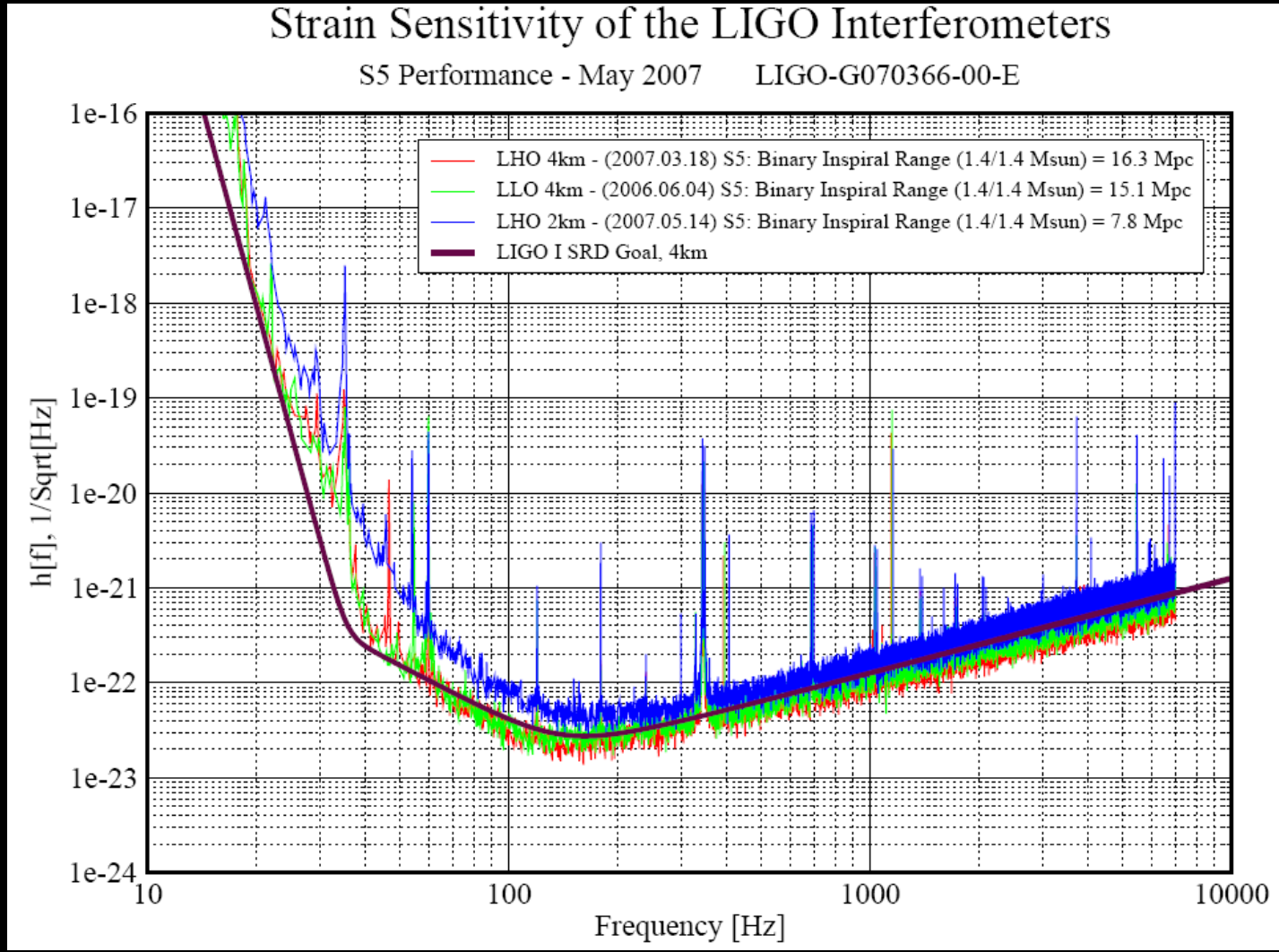

G080565-00



The LIGO Scientific Collaboration (LSC)

- 55 institutions and > 500 people
- The LSC carries out a scientific program of instrument science and data analysis.
- The 3 LIGO interferometers and the GEO600 instrument are analysed as one data set
- LSC & Virgo signed a 'Memorandum of Understanding'
 - Joint data analysis
 - Increased science potential
- Joint run plan
 - Goal of observation of the gravitational sky over the next decade

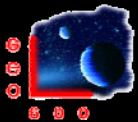

G080565-00



Astrophysical searches

- Five science runs to date involving LIGO, GEO and recently VIRGO (> 20 publications)
- Continuous waves
 - Rapidly rotating deformed neutron stars
 - Known radio pulsars (using radio and X-ray observations to provide signal phase) and unknown sources
 - Coherent and semi-coherent searches
 - Targeted (supernova remnants, globular clusters, galactic centre, X-ray sources) and all-sky searches
- Compact binary coalescences
 - late stage neutron star or black hole binary inspirals, mergers and ring-downs
- Transient searches
 - Coincident excess power from short duration transient sources
 - External triggers: GRBs, X-ray transients, radio transients, supernova, neutrino observations
- Stochastic background
 - Cosmological i.e. from inflation
 - Combined background of astrophysical sources
- There is some possibility of detection with the initial instruments
 - For example, binary black hole rates could be as high as 1 event per 4 years

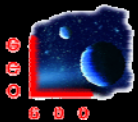

G080565-00



Fifth science run

- S5 started in Nov 2005 and ended Oct 2007
 - LIGO collected 1 year of triple coincidence data at design sensitivity
 - Duty cycle: ~75% per interferometer, 53% triple coincidence
- GEO joined
 - in overnight & weekend mode January 20th 2006
 - in 24/7 mode May 1st 2006 (Duty cycle: ~91%)
 - back in overnight & weekend mode Oct. 2006 - Oct. 2007
- VIRGO joint May 18th 2007 (VSR1)
 - Duty cycle: 81%

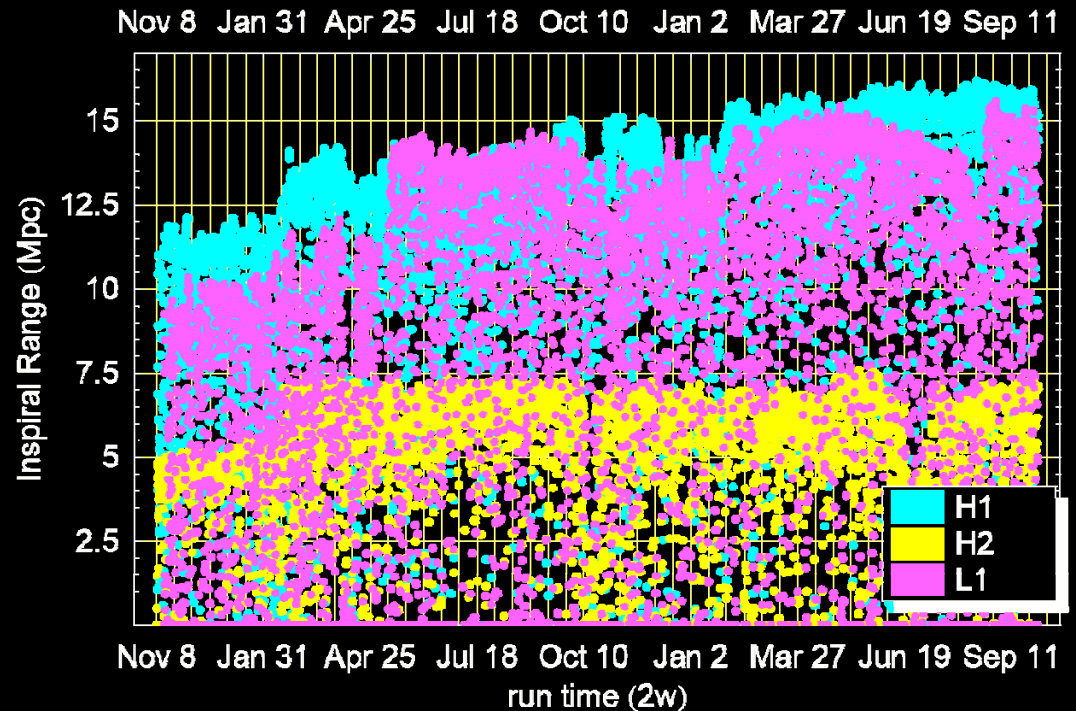

- A figure of merit is the range to which a NS/NS binary ($1.4 M_{\odot}$) is seen at SNR of 8
 - LIGO: 4km range 15 Mpc, 2km range 7 Mpc
 - VIRGO: range 4 Mpc

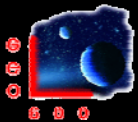

Crab pulsar search

- Known pulsars provide an enticing, well defined, target for GW searches
- Crab pulsar has largest spin-down rate of any known radio pulsar at 3.7×10^{-10} Hz/s
- Assuming all energy is dissipated by GW emission we can set a spin-down upper limit on the strain at 1.4×10^{-24} ($I_{zz} = I_{33} = 10^{38} \text{kgm}^2$, $r = 2$ kpc)
 - largest for any pulsar within the band and beatable with several months of LIGO fifth science run data (S5)
- Nebula emission and acceleration are powered by the spin-down, but uncertainties in the error budget could leave ~80% of the available energy unaccounted for

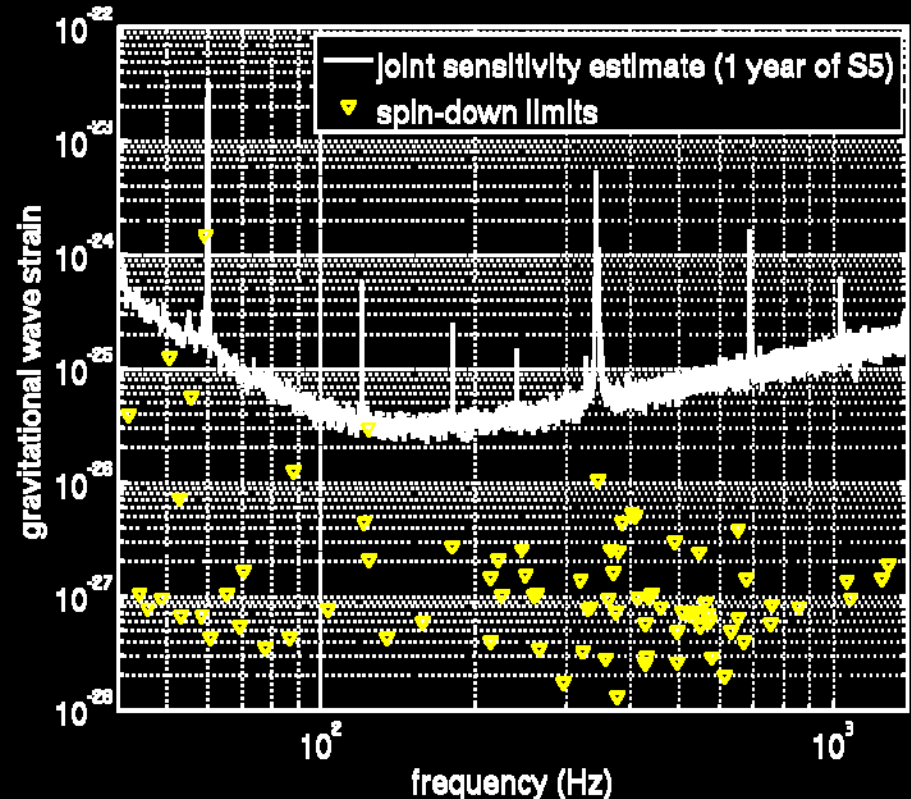

An estimate of the joint LIGO sensitivity for known pulsar searches using 1 year S5 data, and spin down upper limits for known millisecond pulsars

Abbott et al, Ap. J. Lett. 683 (2008) 45

Crab pulsar search

- Using 9 months of combined LIGO S5 data no GW signal from the Crab pulsar was seen, but...
 - We have a limit on the GW amplitude of $h_0 = 3.4 \times 10^{-25}$ - a factor of 4.2 lower than the classical spin-down limit
 - The ellipticity result of 1.8×10^{-4} is into the range permitted by some exotic quark star equations of state (Owen, *Phys. Rev. Lett.*, 2004, Lin, *Phys. Rev. D*, 2007, Haskell et al, *Phys. Rev. Lett.*, 2007)
 - Constrains the amount of the available spin-down power radiated away via GWs to less than 6%
 - Observational constraints of pulsar orientation (Ng and Romani, *Ap. J.*, 2007) can be used and improve our limit to be 5.3 times lower than spin-down
 - Pulsar's braking index of $n=2.5$ shows that pure GW emission is not responsible for spin-down ($n=5$), and from this Palomba (*A&A*, 2000) suggest a spin-down limit 2.5 times lower than the classical one - still beaten by our result
- Represents new regime being probed only through GW observations



Credit: NASA/CXC/SAO

Triggered searches

- 213 GRB triggers during S5 (mainly from Swift, INTEGRAL, IPN, HETE-2)

- time and positional information for GW search
- more confidence in detection (eventually) and allows more source information to be extracted

Abbott et al, *Astrophys. J.* 681 (2008) 1419

Detected by Konus-Wind, INTEGRAL, Swift, MESSENGER

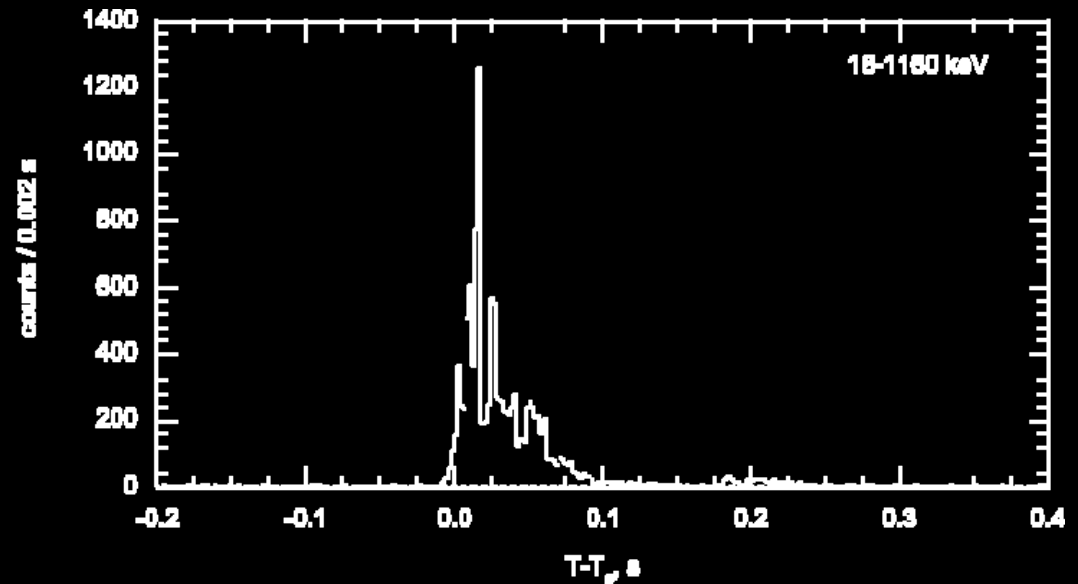

- Particularly interesting short, hard event, GRB070201, observed with a position coincident with spiral arms of M3 - distance 770 kpc
- Possible progenitors for short GRBs:
 - NS/NS or NS/BH mergers: Emits strong gravitational waves
 - Soft gamma-ray repeater (SGR): May emit GWs, but weaker

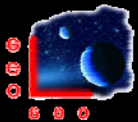

G080565-00



GRB070201 model based inspiral search

Using matched filtering with an inspiral template bank
no plausible GWs were identified

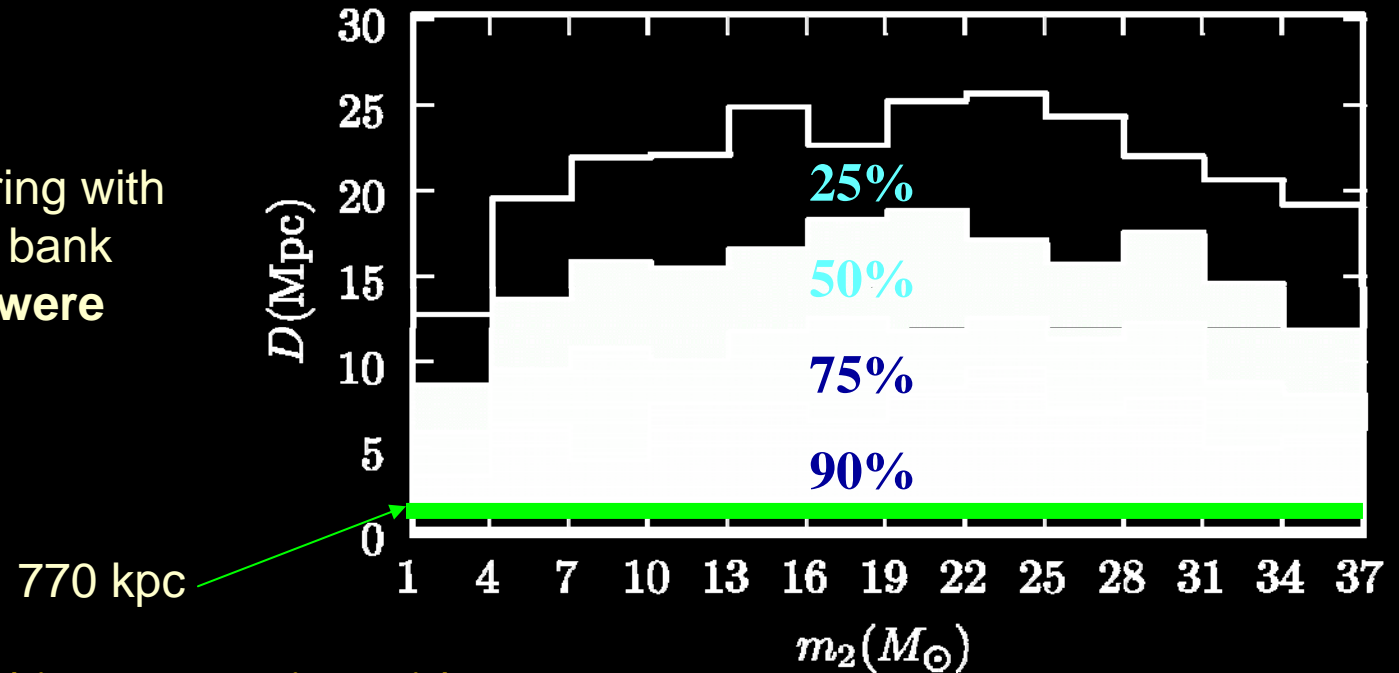

- Exclude compact binary progenitor with masses
 - $1 M_\odot < m_1 < 3 M_\odot$ and $1 M_\odot < m_2 < 40 M_\odot$ with $D < 3.5$ Mpc away at 90% CL
- Exclude any compact binary progenitor in our simulation space
 - at the distance of M31 at $> 99\%$ confidence level

GRB070201 SGR search

- A hypothesised model for the GRB is an Soft Gamma Repeater (SGR) giant flare
- Energy release in γ -rays is consistent with SGR model
 - measured γ -ray fluence = 2×10^{-5} ergs/cm² (Konus-Wind)
 - Corresponding γ -ray energy, assuming isotropic emission, with source at 770 kpc (M31): $\sim 10^{45}$ ergs
 - SGR models predict energy release in GW to be no more than $\sim 10^{46}$ ergs

Limits on GW energy release from GRB 070201 are consistent with an SGR model in M31 (can not exclude it)

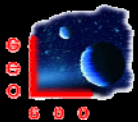

G080565-00



Planned detector evolution 1

- Most probable rate of binary black hole coalescences detectable by the LIGO system ~ 1/4 - 1/600 years
- Thus detection at the sensitivity level of the initial detectors is not guaranteed
 - Need another X 10 to 15
 - then rate of detectable black hole coalescences : ~ 10s to 100s per year

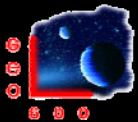

G080565-00



Currently:

- LIGO and Virgo

- 2007 - 2009 incremental detector enhancements

Enhanced LIGO:

higher laser power, better optical readout, higher power optics -> x 2 enhancement in sensitivity

VIRGO +

higher laser power, and silica suspensions (?) to reduce thermal noise, better optical readout -> x ? Improvement

Meanwhile GEO + LIGO H2 + bar detectors are maintaining 'Astrowatch'. until early 2009 when enhanced detectors start operation.

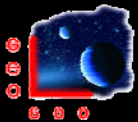

G080565-00



Plans for Advanced detectors

To move from detection to astronomy the current detector network will upgrade, starting 2011, to a series of 'Advanced' instruments with sensitivity improvements of 10 to 15 allowing potential BH-BH coalescence rates of up to 500 per year to be observed.

- Advanced LIGO
- Advanced Virgo
- GEO-HF
- Large Cryogenic Gravitational Telescope (LCGT)

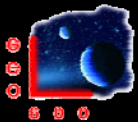

G080565-00



Advanced LIGO

Achieve x10 to x15 sensitivity improvement:

GEO technology being applied to LIGO

- silica suspensions
- more sophisticated interferometry
- more powerful lasers from our colleagues in Hannover

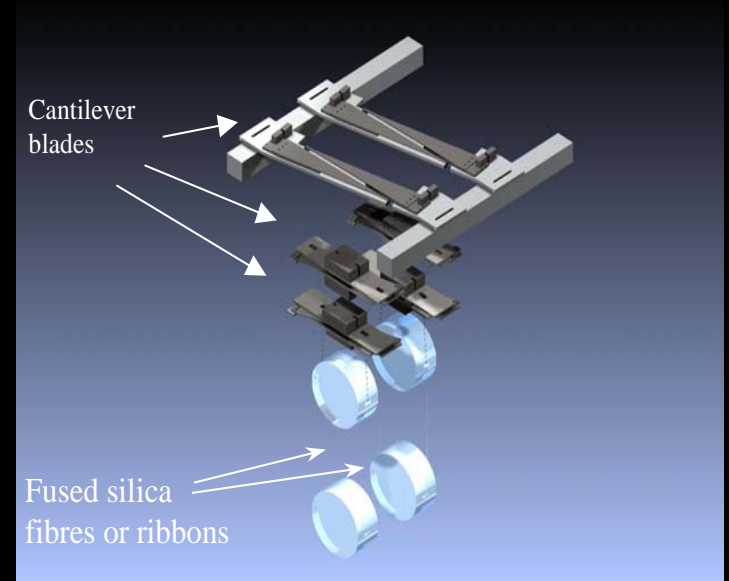

Plus active isolation, high power optics and other input from US groups

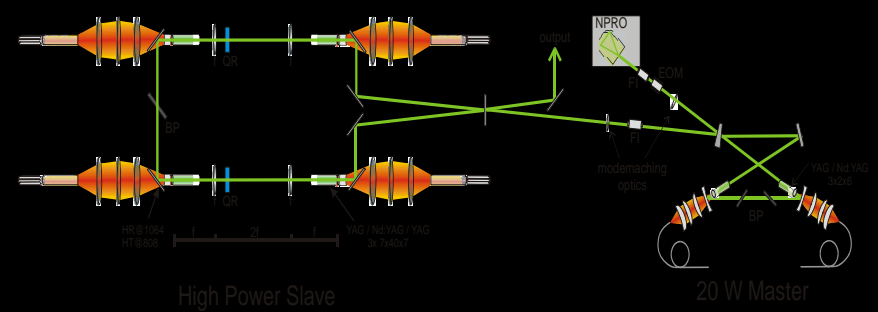
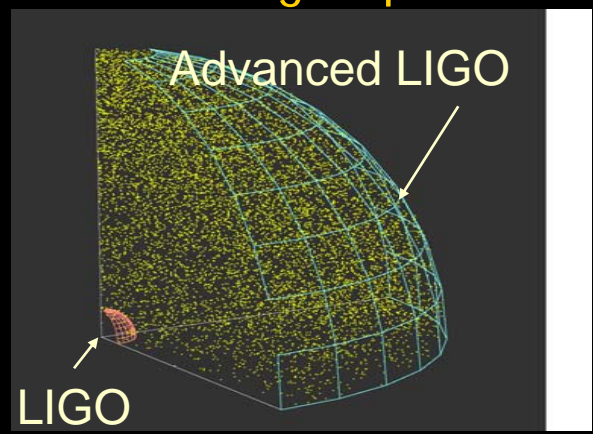

G080565-00



Status of Advanced LIGO

- R&D funded in US, UK and Germany
- Capital contributions funded in UK and Germany (~ £8M from PPARC/STFC and an equivalent amount from MPG)
- Advanced LIGO Project Start now approved from 1 April 2008 in USA to allow re-construction on site starting 2011
- Full installation and initial operation of 3 interferometers by 2014

Advanced LIGO is making excellent progress

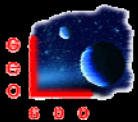

G080565-00



Advanced VIRGO

- Planned sensitivity improvement is a factor of 10 over VIRGO sensitivity
- Implementation will start 2011
- Hardware upgrades (laser power, optics, coatings, suspensions and others) will be installed
- Re-commissioning period will be 2012-2013
- Operation on same timescale as Advanced LIGO



Large Cryogenic Gravitational Telescope (LCGT) (Japan)



Planned for construction in the Kamioka mine in Japan

Will use sapphire mirrors cooled to 40K

Not yet funded – proposal still being developed

Sensitivity goals very similar to Advanced LIGO and Advanced VIRGO

Challenges of the field for 3rd Generation

- For a further factor of ten sensitivity improvement we need to
 - fully understand and further reduce seismic and thermal noise from mirrors and suspensions
 - improve interferometric techniques to reduce the significance of quantum noise in the optical system
 - refine data analysis techniques
- A design study for such a detector [the Einstein gravitational-wave Telescope - 'ET'] has now been funded by the EC under FP 7

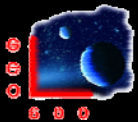

G080565-00



Advanced detector network

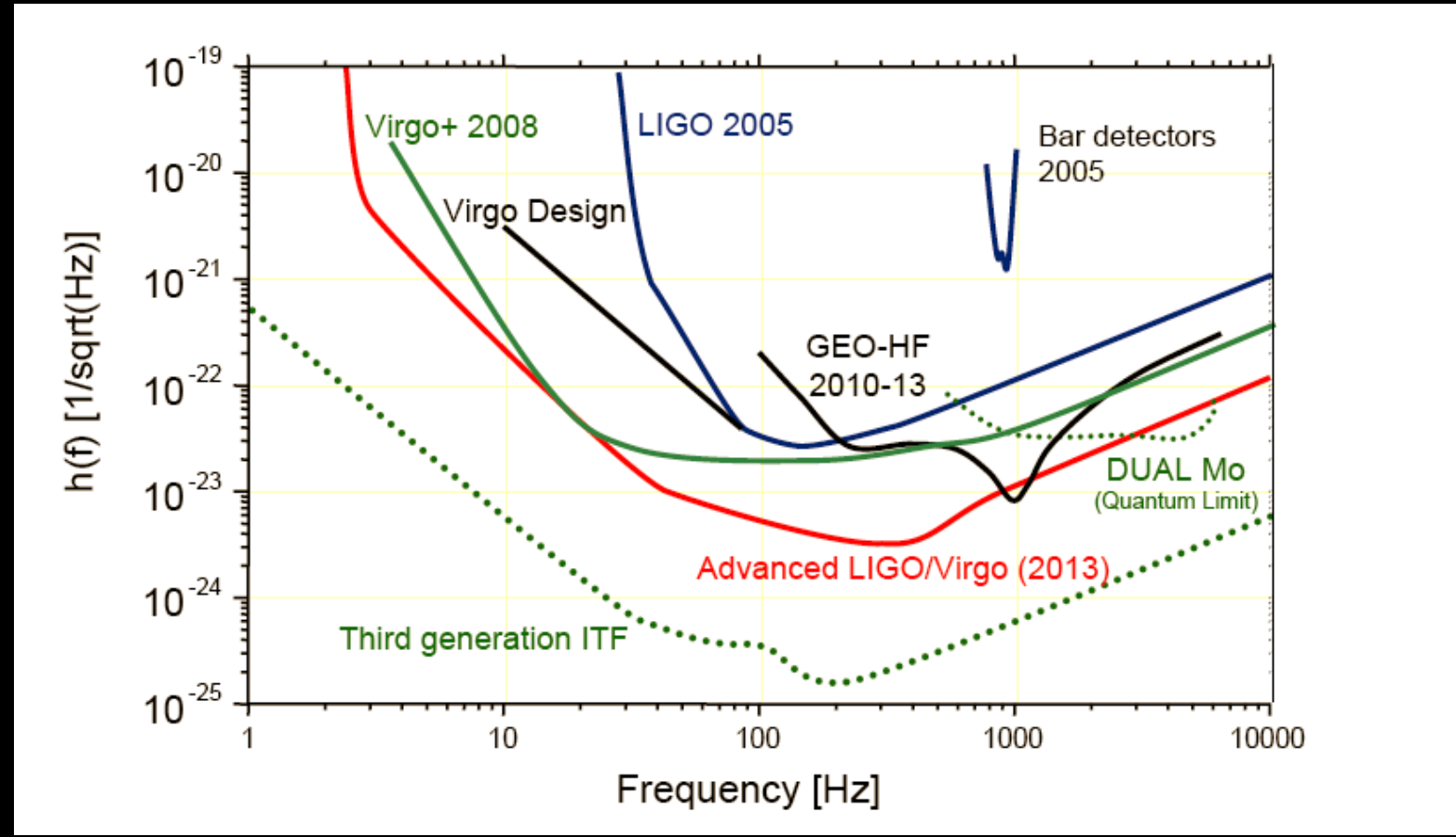

G080565-00



Future detectors and data taking plans

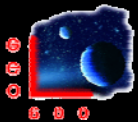
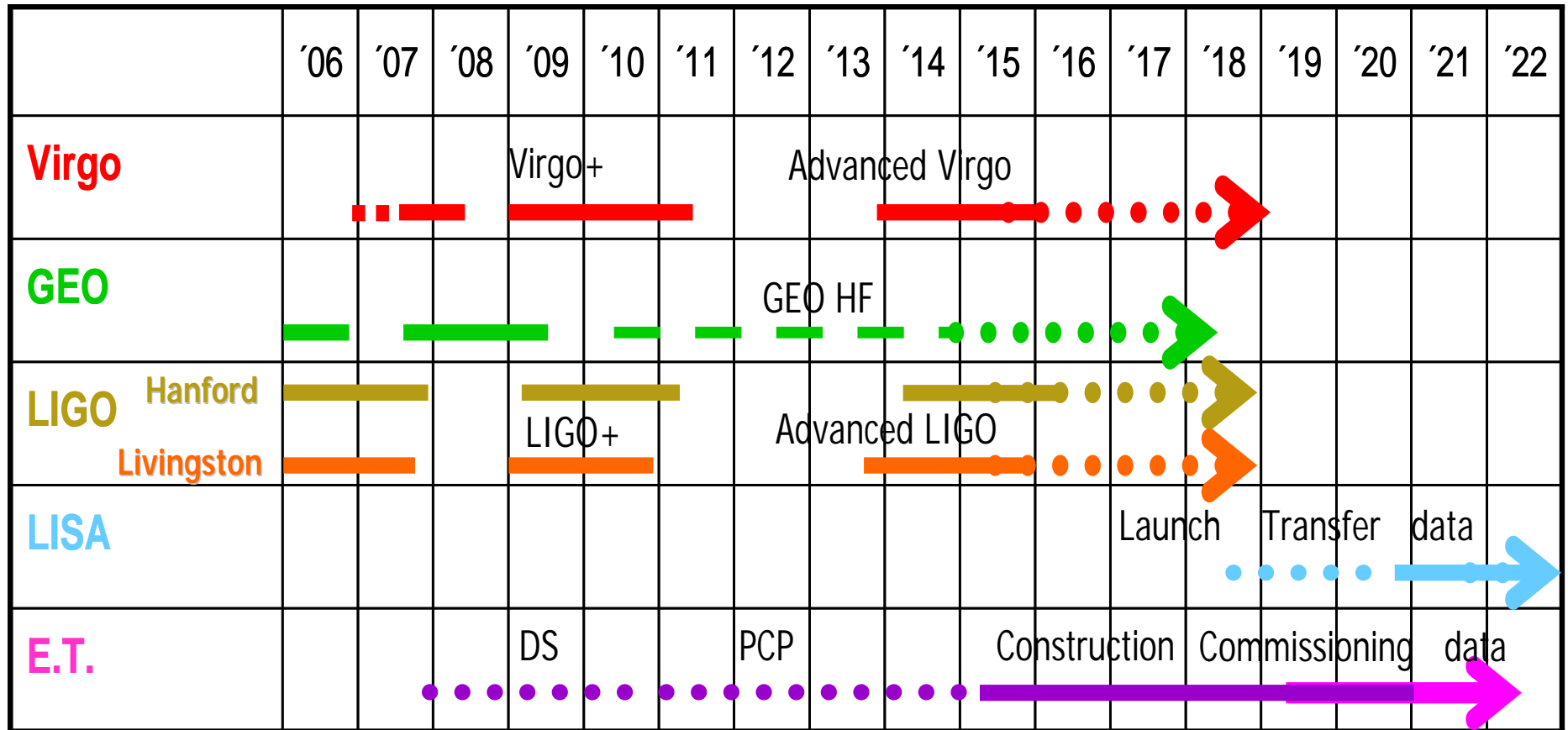

G080565-00



Sources - reminder

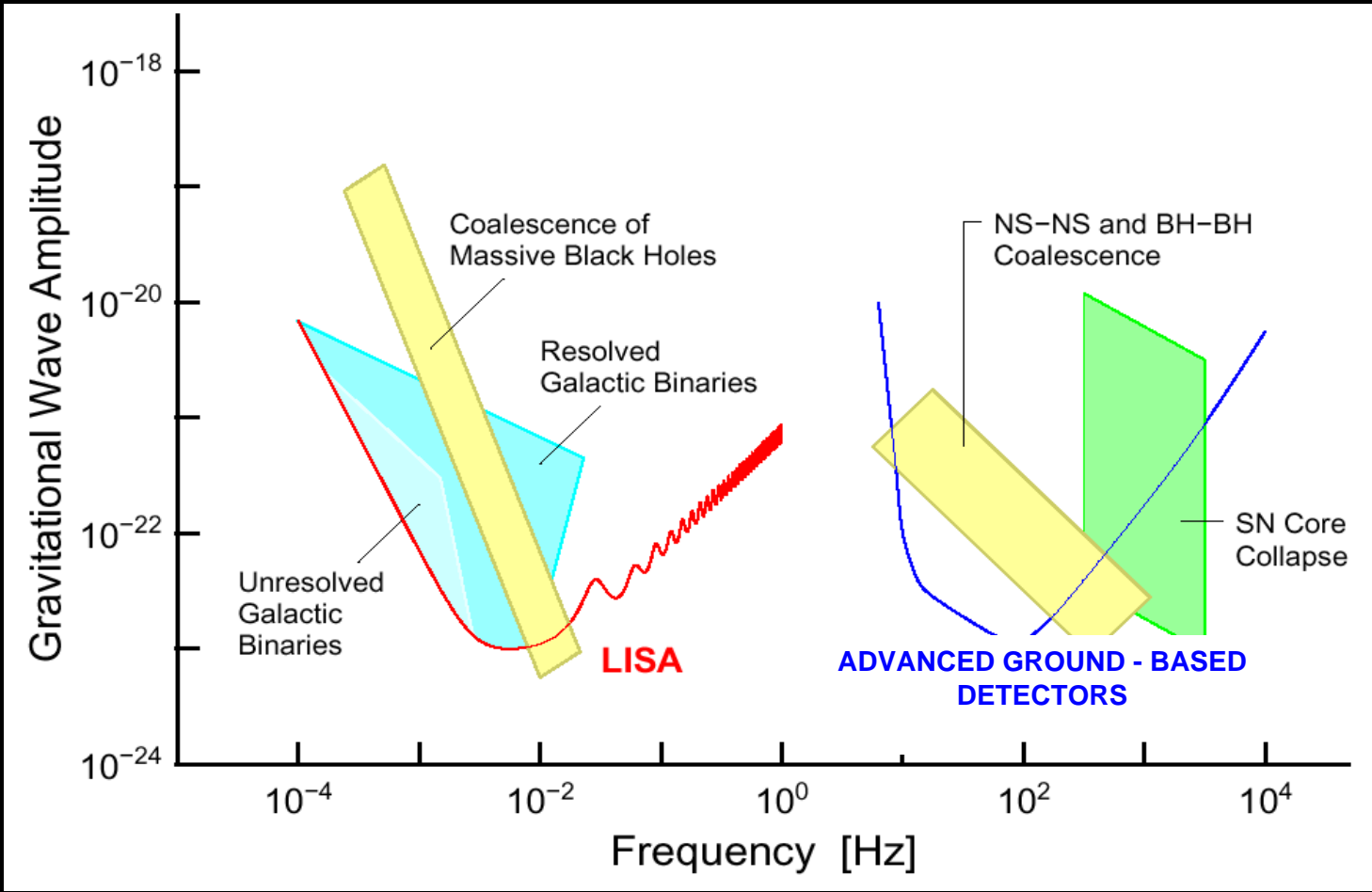

G080565-00



LISA - Cluster of 3 sp'craft in heliocentric orbit at 1 AU

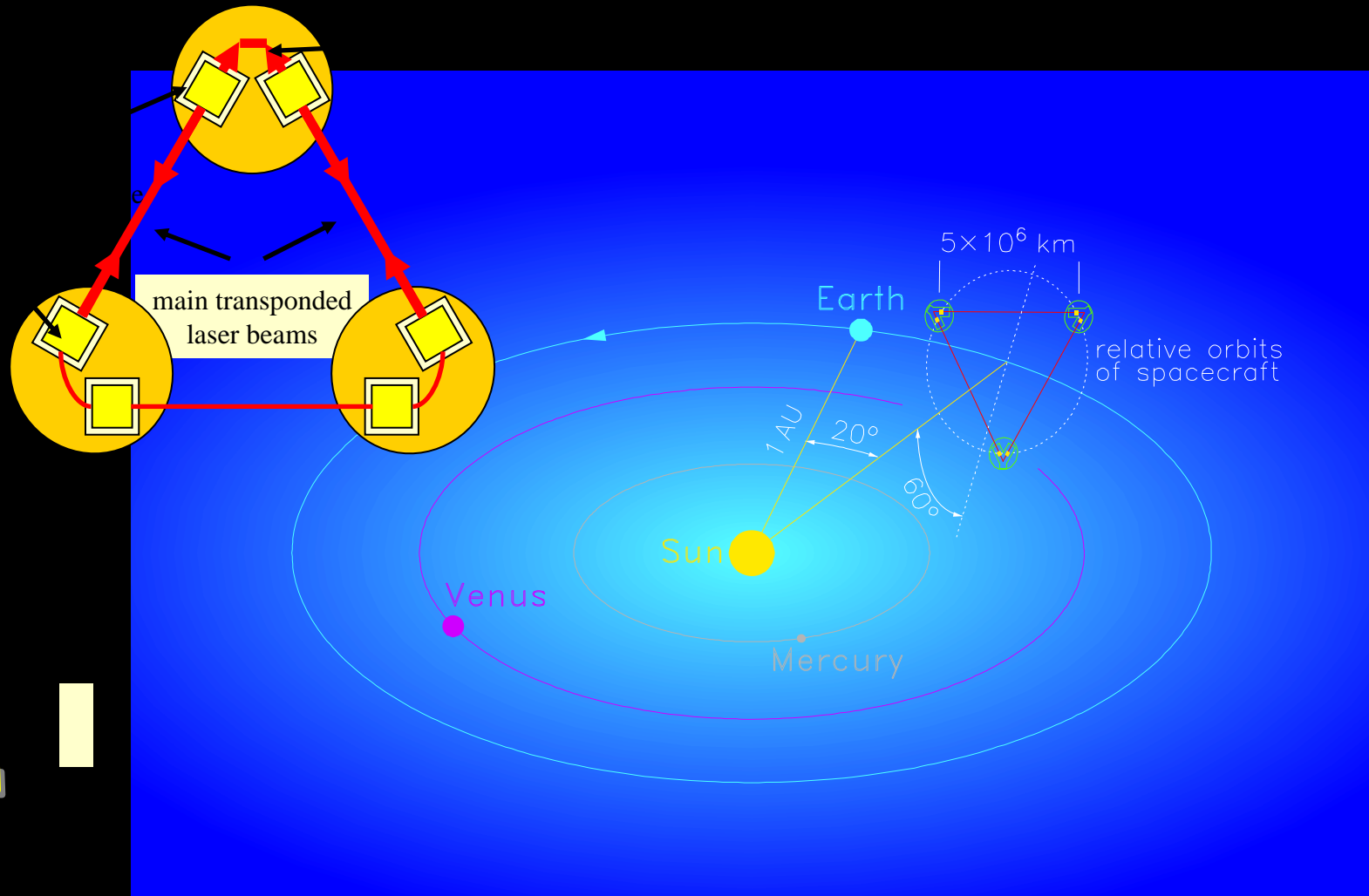

LISA



G080565-00



LISA Pathfinder Concept - Technology demonstrator for launch in 2010

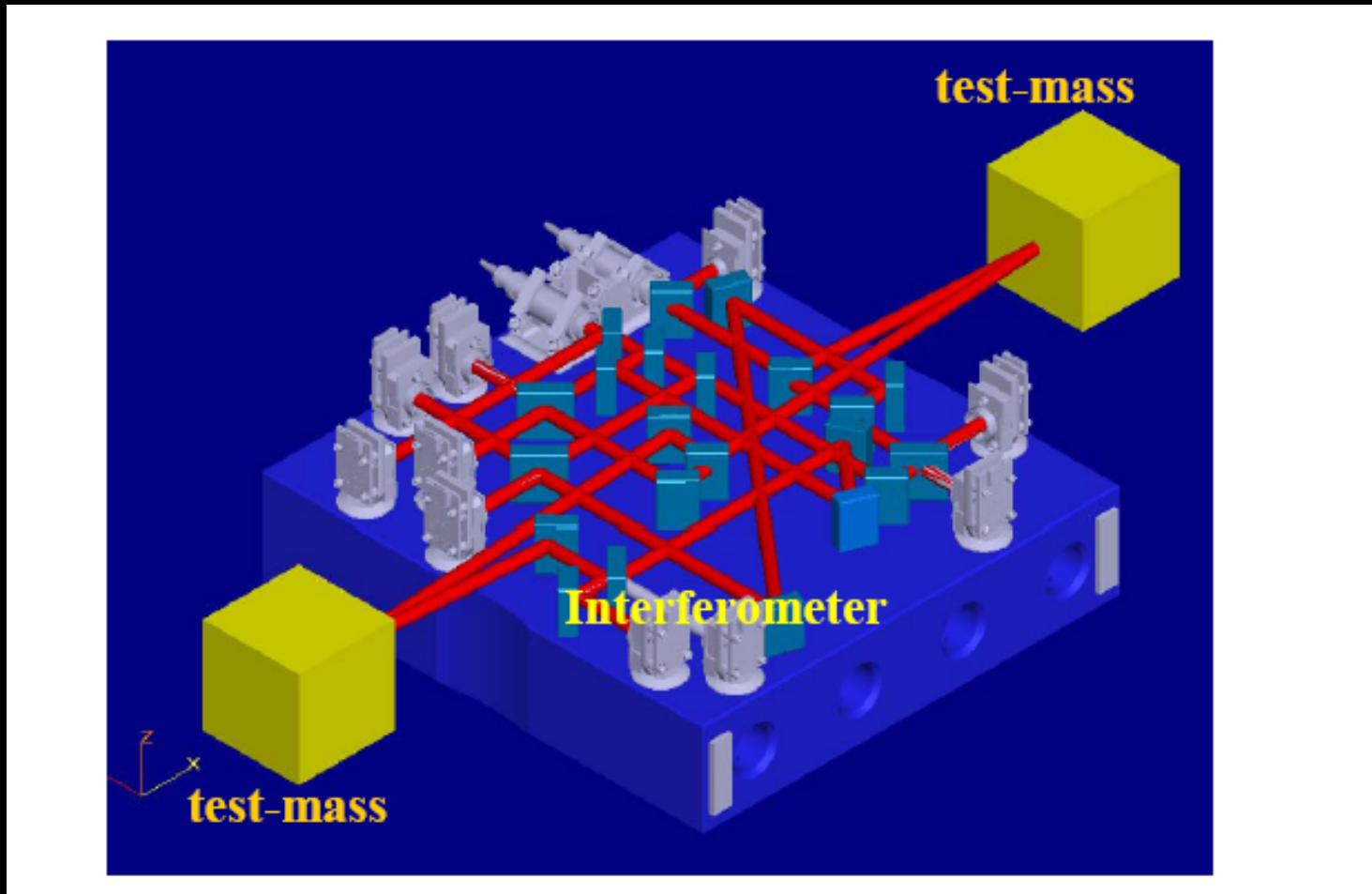

The Network of Gravitational Wave Facilities

- 1st generation on ground are operating and taking data
- 2nd generation follows 2010-14, designs mature,
 - Advanced LIGO (USA/GEO Group/LSC)
 - Advanced VIRGO (Italy/France +GEO Group?)
 - Large Cryogenic Gravitational Telescope (LCGT) (Japan)
 - GEO-HF (GEO/LSC)
- 3rd generation
 - Lab research underway around the globe
 - Plans for a design proposal under FP7 framework for a 3rd generation detector in Europe
- LISA - spaced based detector
 - Planned for launch 2018

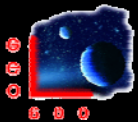

G080565-00



Gravitational Wave Astronomy

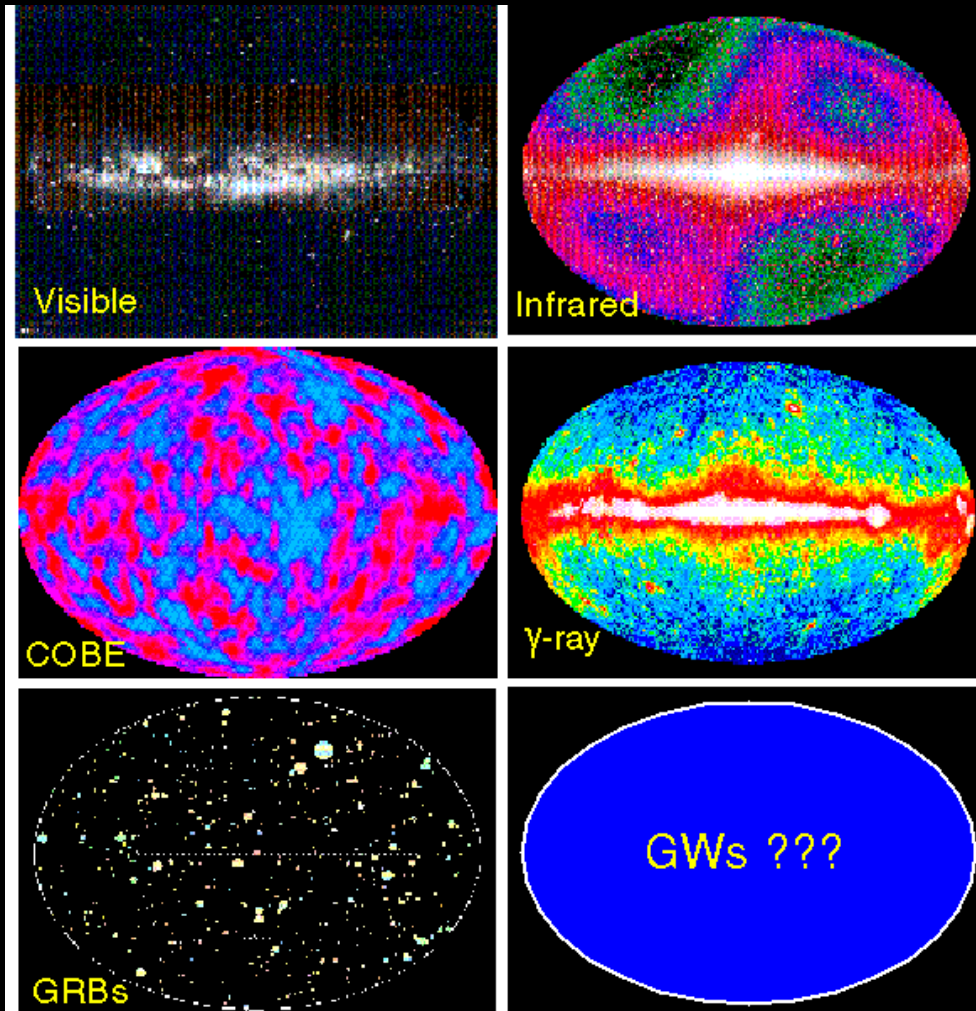

A new way to observe the Universe

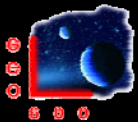

G080565-00

